



Scaffold • Shoring • Tube & Clamp • System

MANUFACTURING & SALES



2024-2025 PRODUCT CATALOG



19902 Hufsmith-Kohrville Rd • Tomball, TX 77375
877-890-8490 | 281-890-6150 (FAX)
www.STVAonline.com | e-mail: order@stvaonline.com



BUY DIRECT FROM THE MANUFACTURER

*Your Satisfaction
is our #1 Goal*



*All of our
scaffolding
goes through **FOUR**
rigorous **quality control**
checks to ensure all scaffold
industry standards are met.*

- US Owned, US Engineered
- Competitive Prices
- Safe Products - By US Safety Standards
- Cutting Edge Product Development

All STVA Welders are certified to AWS D1.1 structural welding fabrication code - WPS, and welder certs can be supplied upon request. US Certificate of Insurance Available Upon Request.

*Call today for a **FREE** specialized quote:*

877-890-8490

TABLE OF CONTENTS

S-Style Walk-Thru Frames	6	Mortar Tubs.....	25
S-Style Mason Frames.....	7	Mortar Stands.....	25
W-Style Walk-Thru Frames.....	8	Veneer Jacks.....	25
W-Style Mason Frames.....	9	Multipurpose/Interior Scaffold	26
V-Style Walk-Thru Frames	10	Tube and Clamp Scaffold.....	27
V-Style Mason Frames	11	Scaffold Clamps.....	27
BJ-Style Walk-Thru Frames.....	12	H.L. 10K Shoring Frames	28
Coupling Pins & Connectors	13	25k Shoring Frames.....	29
Clips & Pins	13	10-25k Shoring Accessories.....	30
Accessories	14	10k Nominal Range Post Shores	31
Angle Iron Cross Braces	15	25k Nominal Range Post Shores	31
Tube Cross Braces	15	10-25k Shoring Accessories.....	32-33
Diagonal Goosers.....	15	Aluminium Beams/Joist	33
Tube Straddle Braces.....	15	25k Shoring Accessories	34
Locks	16	System Scaffold Equipment.....	35
Locking Casters.....	16		
Base Plates.....	16		
Outrigger.....	17		
Brackets	17		
Wall Ties.....	17		
Internal Stair Units	18		
Ladders.....	19		
Ladder Brackets.....	19		
Panels	19		
Guard Rail Panels & Gates	20		
Guard Rails.....	20		
Planks & Decking	21		
Guard Rail Posts.....	22		
Putlogs.....	23		
Scaffold Tags.....	23		
Storage & Shipping Rack & Basket.....	23		
Screw Jacks.....	24		
Concrete Forming Accessories	24		
Hoist Arm & Well Wheels	25		
Folding A-Frames	25		
Stanchions.....	25		



OUR QUALITY POLICY

*Your Satisfaction
is our #1 Goal*



U.S. Insured

Largest Inventory

International Shipping

Domestic Shipping

ANSI/SAIA Tested

OSHA Certified Staff

QUALITY STATEMENT

STVA Scaffold is absolutely committed to meeting and exceeding our customer's quality and service expectations. I personally affirm this commitment. I am leading the effort to establish a quality scaffold manufacturing system, which will assure our customers receive the best quality products we can provide. We are committing ourselves to a strategy of continuous improvement, relentlessly seeking to learn the expectations of our customers, and striving to meet and exceed those expectations of our customers with this quality system.

We intend for these efforts to help us meet the following goals:

- Maintain our position at the cutting edge of scaffolding product development and technology.
- Maintain our reputation for quality scaffold products, service, and industry responsibility.

The entire STVA Scaffold Division must adhere to the Panaseas International, Inc. quality policy as well as the directives of the quality manual. I am actively involved in building this exciting new effort as a member of the quality assurance team as well as following through with the execution of various responsibilities. We treat each and every customer how we would like to be treated. We thank you for your business.

Sincerely,

SANDRA K. CZICHOS

CEO Panaseas International, Inc.

**WHEN YOU
ARE SATISFIED,
WE ARE
SATISFIED!**



ABOUT OUR COMPANY

STVA Scaffold is completely owned by a US (Houston) corporation. Our CEO has over fifty years of experience in owning and operating a business. It has been our company's policy to do business the old-fashioned way, on a hand shake. We carry US insurance covering all products we sell. Our factory and products are designed and built to US standards by US engineers. STVA Scaffold manufactures most of the products depicted in this catalog.

We pride ourselves in providing a quality product at a great price. Panaseas International, Inc., the parent company of STVA Scaffold, has been in business for 18 years manufacturing a wide range of products. As a manufacturer, we are able to explore other products that are not listed in this catalog. Using our expansive shipping capabilities, STVA Scaffold is able to distribute our products worldwide.

We expanded our plant facilities in 2015. Our new state-of-the-art manufacturing facility is more than capable of meeting the production needs of any size job. This new manufacturing facility in Rizhao, China is totally committed to maintaining production of metal products for our scaffold and shoring division. The new plant consists of two 70,700 square foot buildings for a total of 141,400 square feet under cover on 15 acres, an office building with 6,000 square feet, as well as a dormitory, which houses 100 workers with a dining room and kitchen facility. The entire plant is operational 7 days a week, 24 hours a day. This gives us the capability to provide better overall control of our scaffold quality.

We have a competent staff of engineers and technicians, as well as a knowledgeable sales force. We will assure you the highest quality, safety, and service available. We meet or exceed the highest industry standards with all of our scaffold, system, and shoring products. If you have any questions or comments, please do not hesitate to call or e-mail our sales staff.

STVA Scaffold is not certified to erect scaffolding, design false works structures or construct scaffolding units past the production phases. STVA Scaffold is not responsible for improper use of its scaffolding products. End users should consult an engineer about proper specifications for structures. As a manufacturer, STVA's liability is limited to our manufactured products.



S-STYLE

Walk-Thru Frames

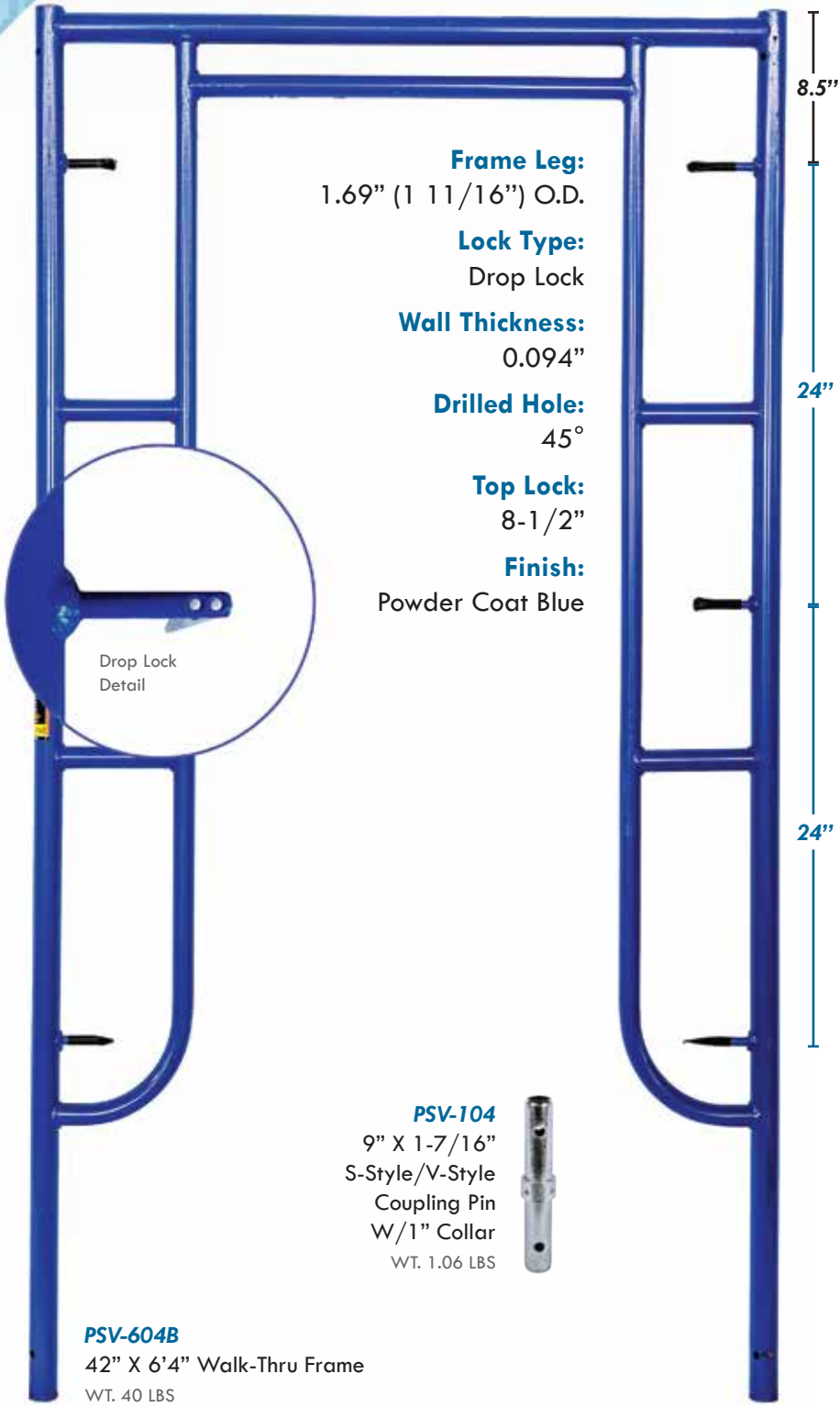

Frame Leg:
1.69" (1 11/16") O.D.

Lock Type:
Drop Lock

Wall Thickness:
0.094"

Drilled Hole:
45°

Top Lock:
8-1/2"

Finish:
Powder Coat Blue

Drop Lock
Detail

PSV-104
9" X 1-7/16"
S-Style/V-Style
Coupling Pin
W/1" Collar
WT. 1.06 LBS



PSV-604B
42" X 6'4" Walk-Thru Frame
WT. 40 LBS

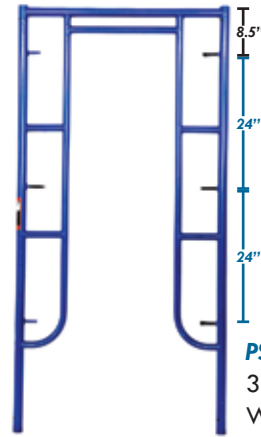

PSV-601B
3' X 6'4" S-Style
Walk-Thru Frame
WT. 41.40 LBS

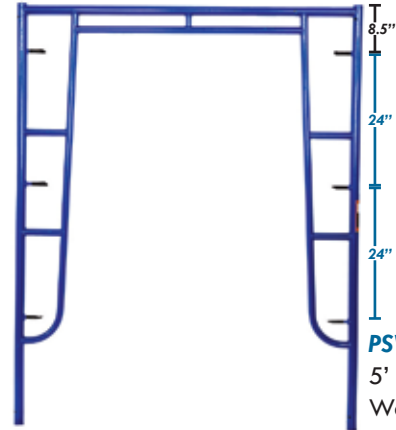

PSV-610B
5' X 6'4" S-Style
Walk-Thru Frame
WT. 46.60 LBS

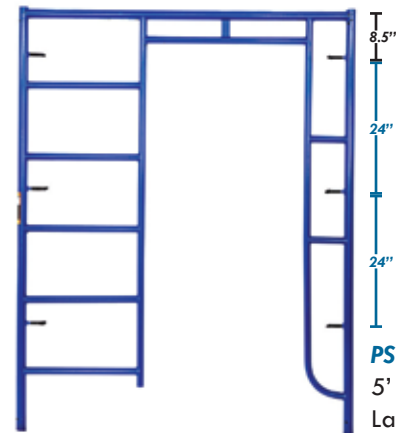

PSV-620B
5' X 6'4" S-Style
Ladder &
Walk-Thru Frame
WT. 52.40 LBS

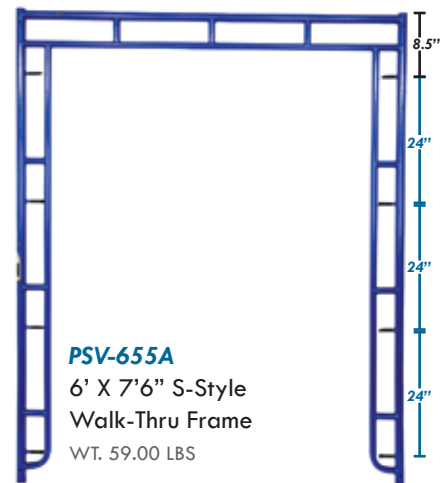

PSV-655A
6' X 7'6" S-Style
Walk-Thru Frame
WT. 59.00 LBS



S-STYLE

Mason Frames



PSV-403B8
3' X 3' S-Style
Single Ladder
WT. 22.40 LBS

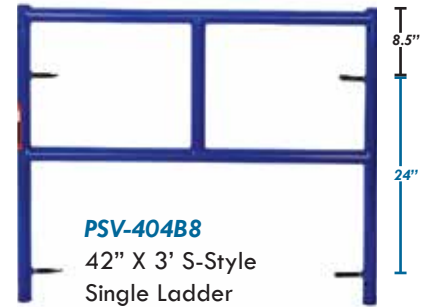

PSV-404B8
42" X 3' S-Style
Single Ladder
WT. 22.20 LBS

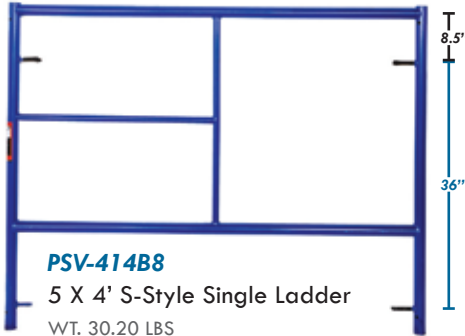

PSV-414B8
5 X 4' S-Style Single Ladder
WT. 30.20 LBS

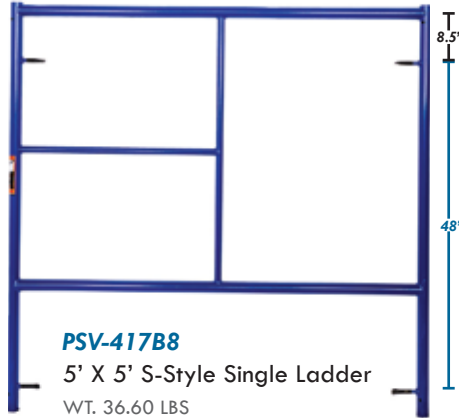

PSV-417B8
5' X 5' S-Style Single Ladder
WT. 36.60 LBS

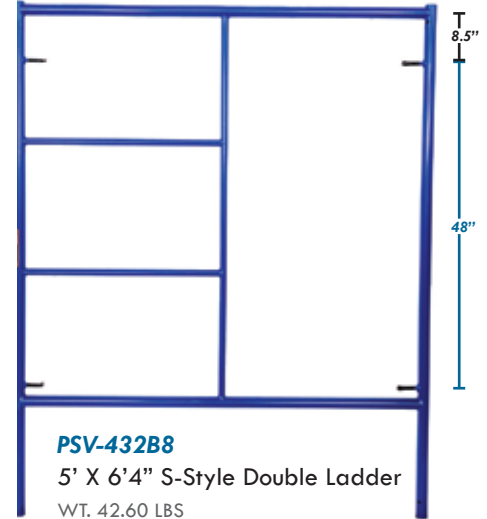

PSV-432B8
5' X 6'4" S-Style Double Ladder
WT. 42.60 LBS



PSV-405B8
5 X 2' S-Style Single Ladder
WT. 23.40 LBS

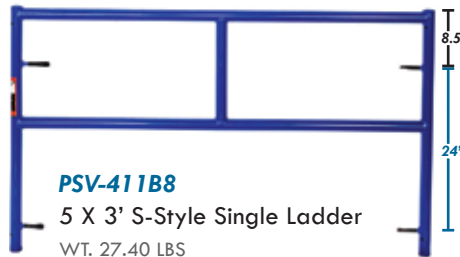

PSV-411B8
5 X 3' S-Style Single Ladder
WT. 27.40 LBS

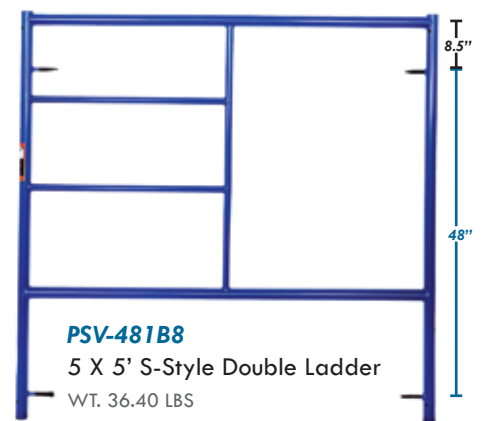

PSV-481B8
5 X 5' S-Style Double Ladder
WT. 36.40 LBS

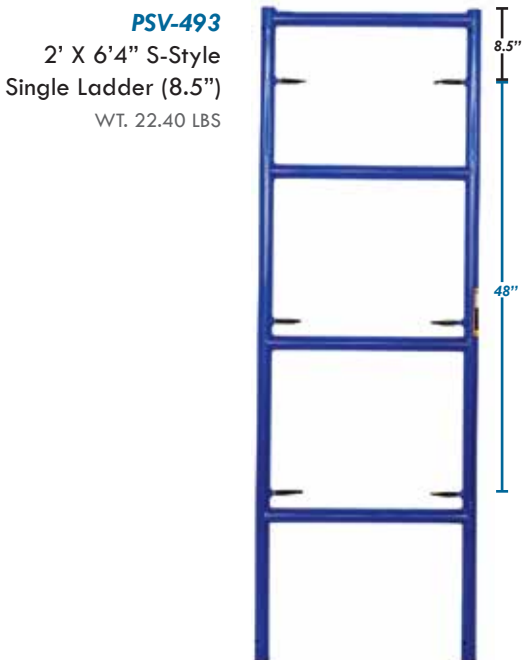

PSV-493
2' X 6'4" S-Style
Single Ladder (8.5")
WT. 22.40 LBS

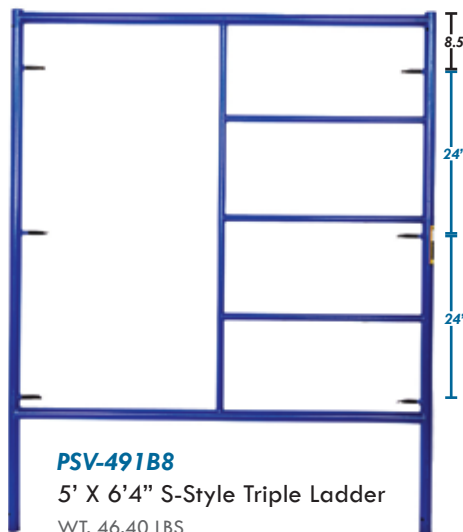

PSV-491B8
5' X 6'4" S-Style Triple Ladder
WT. 46.40 LBS

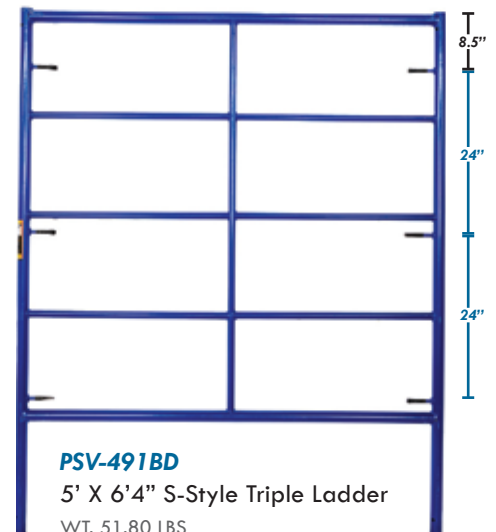

PSV-491BD
5' X 6'4" S-Style Triple Ladder
WT. 51.80 LBS



W-STYLE

Walk-Thru Frames

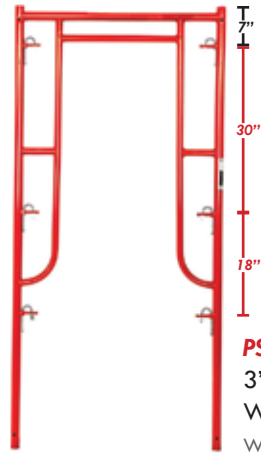

PSV-635AC
3' X 6'7" W-Style
Walk-Thru Frame (2 Rung)
WT. 37.75 LBS

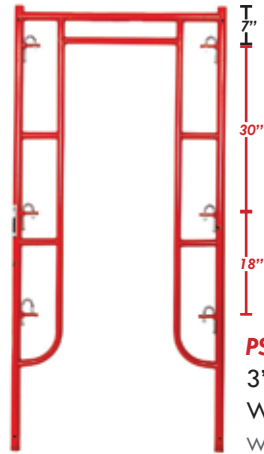

PSV-636AC
3' X 6'7" W-Style
Walk-Thru Frame (3 Rung)
WT. 42.35 LBS

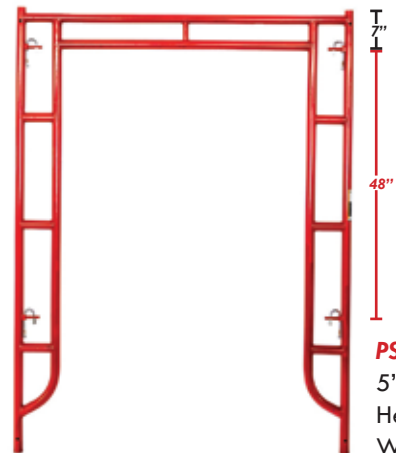

PSV-632AC
5' X 6'7" W-Style
Heavy Duty
Walk-Thru Frame
WT. 37.75 LBS

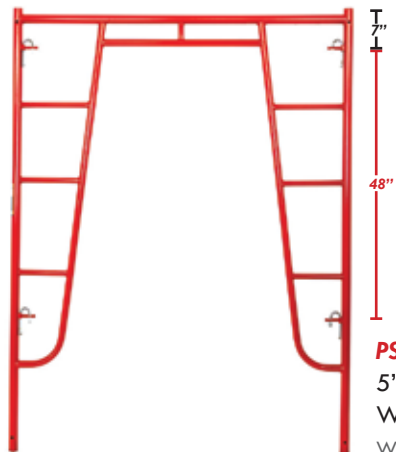

PSV-634AC
5' X 6'7" W-Style
Walk-Thru Frame
WT. 45.56 LBS

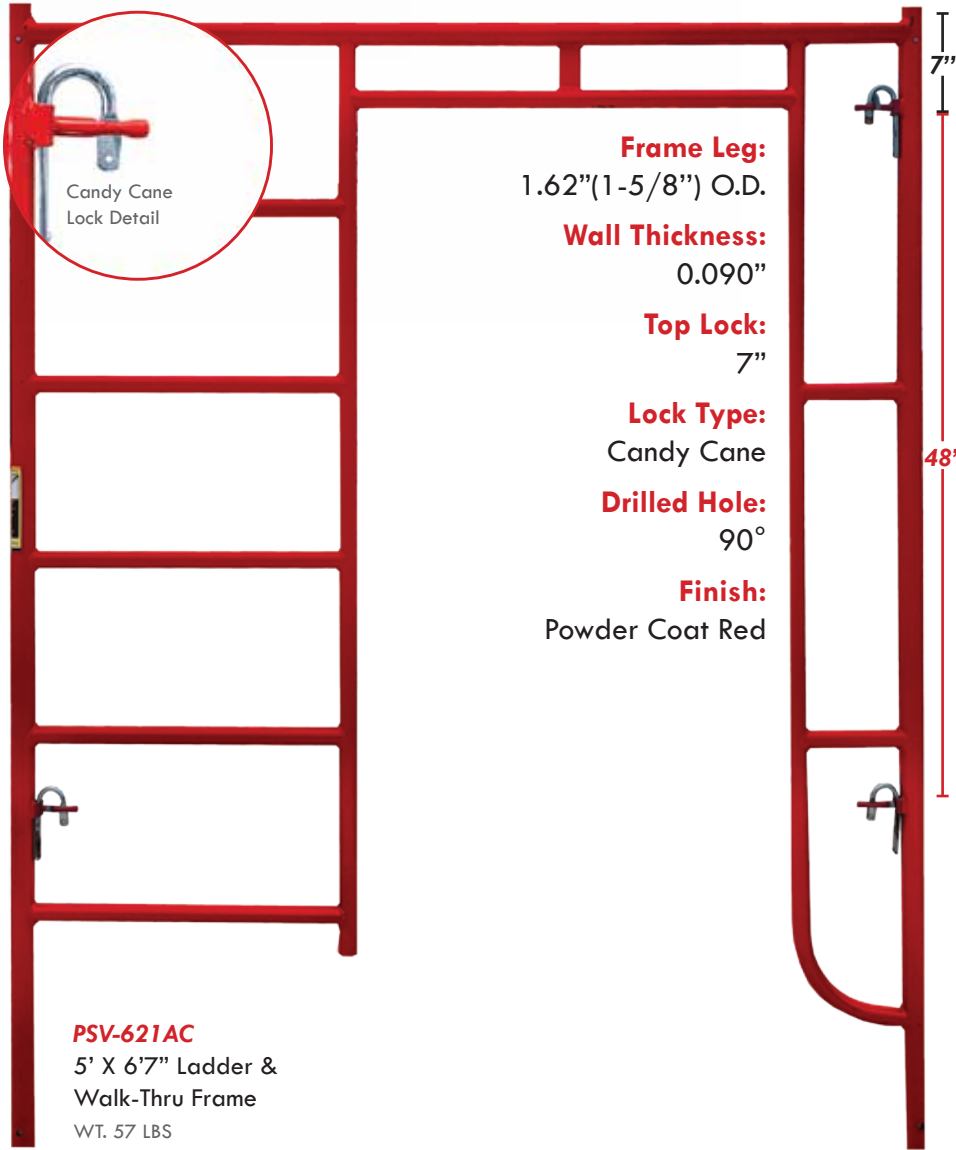

PSV-621AC
5' X 6'7" Ladder &
Walk-Thru Frame
WT. 57 LBS

Frame Leg:
1.62"(1-5/8") O.D.

Wall Thickness:
0.090"

Top Lock:
7"

Lock Type:
Candy Cane

Drilled Hole:
90°

Finish:
Powder Coat Red



Candy Cane
Lock Detail

PSV-100
7" 1-3/8" W-Style
Coupling Pin
W/1/8" Collar
WT. 0.79 LBS



PSV-103
7" 1-3/8" W-Style
Coupling Pin
W/No Collar
WT. 0.59 LBS





W-STYLE

Mason Frames

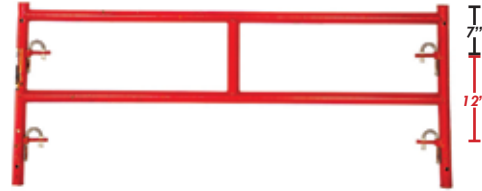

PSV-408A
5' X 2'1" W-Style
Single Ladder
WT. 25.01 LBS



PSV-407A
3' X 3'1" W-Style
Single Ladder
WT. 21.80 LBS

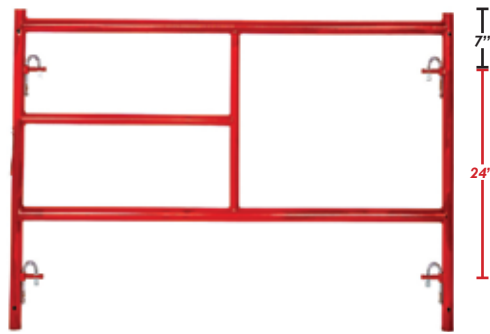

PSV-409A
5' X 3'1" W-Style
Single Ladder
WT. 30.40 LBS

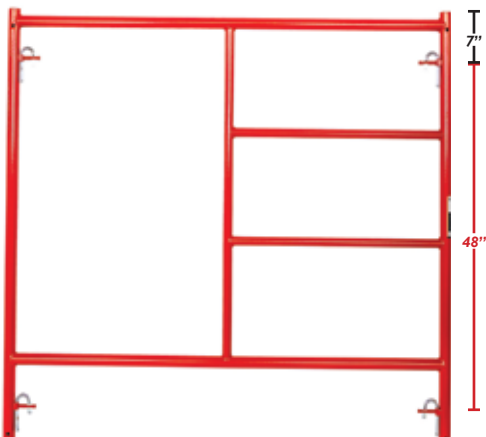

PSV-419A
5' X 5'1" W-Style
Double Ladder
WT. 41.20 LBS

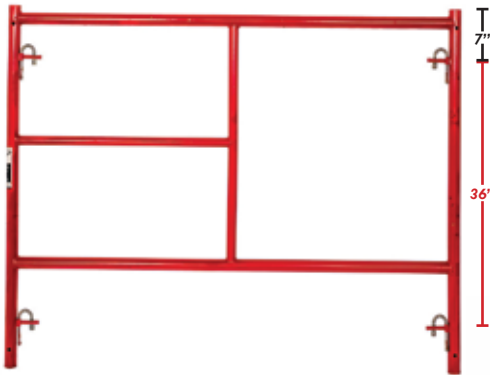

PSV-410A
5' X 4'1" W-Style
Single Ladder
WT. 35 LBS

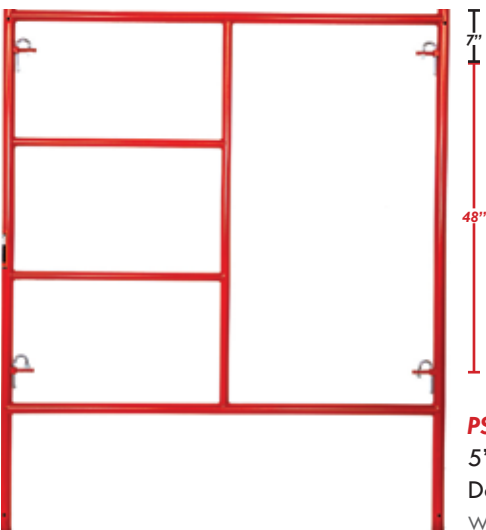

PSV-429A
5' X 6'7" W-Style
Double Ladder
WT. 49.20 LBS



PSV-428A
3' X 6'7" W-Style
Ladder Frame
WT. 36.06 LBS



V-STYLE

Walk-Thru Frames

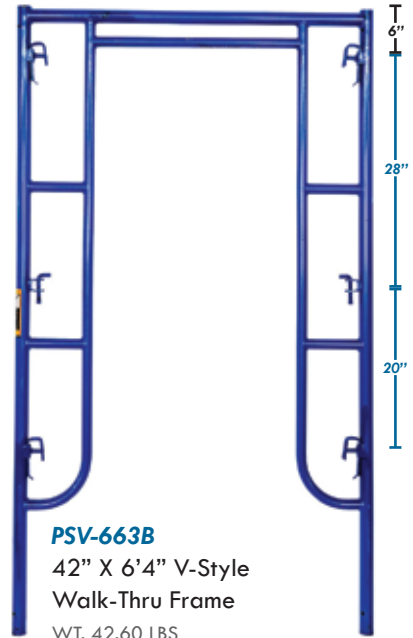



V-STYLE

Mason Frames

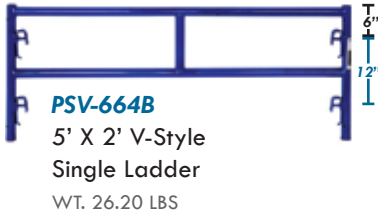

PSV-664B
5' X 2' V-Style
Single Ladder
WT. 26.20 LBS

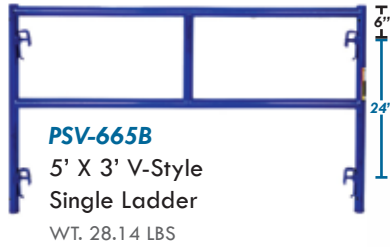

PSV-665B
5' X 3' V-Style
Single Ladder
WT. 28.14 LBS



PSV-666B
3' X 3' V-Style
Single Ladder
WT. 22.80 LBS

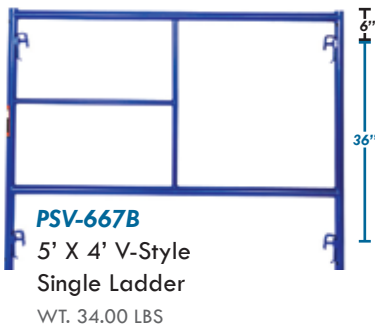

PSV-667B
5' X 4' V-Style
Single Ladder
WT. 34.00 LBS

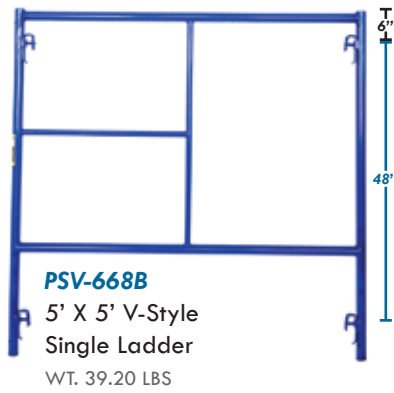

PSV-668B
5' X 5' V-Style
Single Ladder
WT. 39.20 LBS

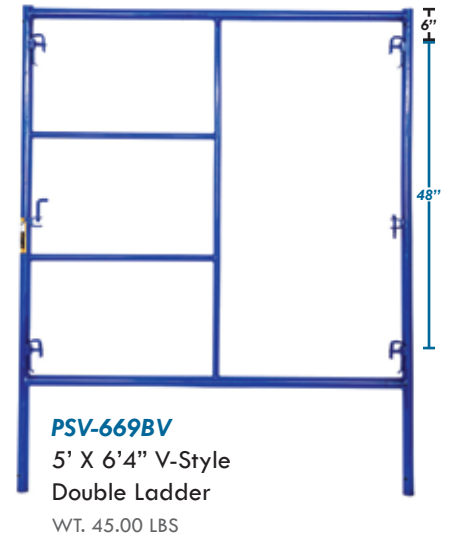

PSV-669BV
5' X 6'4" V-Style
Double Ladder
WT. 45.00 LBS

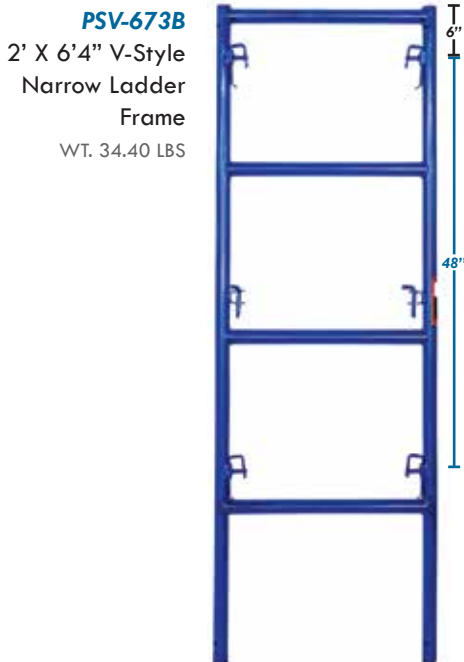

PSV-673B
2' X 6'4" V-Style
Narrow Ladder
Frame
WT. 34.40 LBS



PSV-672B
2 X 5' V-Style
Narrow Ladder
Frame
WT. 29.60 LBS



PSV-671B
2' X 3' V-Style
Narrow Ladder
Frame
WT. 20.20 LBS



BJ-STYLE

Walk-Thru Frames



Frame Leg:
1.625"(1-5/8") O.D.

Wall Thickness:
0.090"

Lock Spacing:
27.75"

Lock Type:
C-Lock

Drilled Hole:
90°

Finish:
Powder Coat Yellow



C-Lock Detail

PSV-107
9" 1-3/8"
W-Style/BJ-Style
Coupling Pin
W/1" Collar
WT. 0.87 LBS



PSV-651A
42" X 6'6" BJ-Style
Walk-Thru Frame
WT. 48.81 LBS

11.75"

27.75"

27.75"

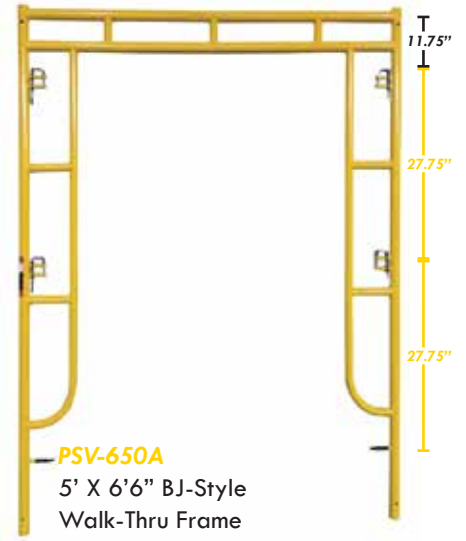

PSV-650A
5' X 6'6" BJ-Style
Walk-Thru Frame
WT. 53.00 LBS

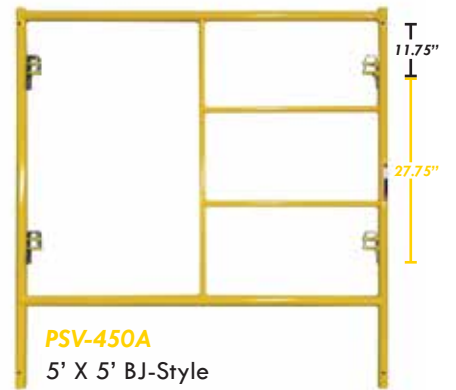

PSV-450A
5' X 5' BJ-Style
Double Ladder Frame
WT. 39.80 LBS



PSV-413A
5' X 3' BJ-Style
Single Ladder Frame
WT. 30.73 LBS



COUPLING

Pins & Connectors



PSV-102
1-7/8" H.L. Shoring
Connector
WT. 0.96 LBS



PSV-102B
1-7/8" Universal
H.L. Shoring
Connector
WT. 1.12 LBS



PSV-100
7" 1-3/8" W-Style
Coupling Pin
W/ 1/8" Collar
WT. 0.79 LBS



PSV-101
9" X 1-1/4" BJ-Style
Coupling Pin
W/ 1" Collar
WT. 0.83 LBS



PSV-103
7" X 1-3/8" W-Style &
BJ-Style (STVA) Coupling
Pin W/ No Collar
WT. 0.59 LBS



PSV-104
9" X 1-7/16" S-Style
Coupling Pin
W/ 1" Collar
WT. 1.06 LBS



PSV-105A
1-3/8" X 1-7/8"
Shoring To W-Style
Coupling Pin
WT. 1.17 LBS



PSV-105B
1-7/16" X 1-7/8"
Shoring To S-Style
Coupling Pin
WT. 1.17 LBS



PSV-107
9" X 1-3/8" BJ-Style
(STVA) Coupling Pin
W/ 1" Collar
WT. 0.87 LBS



PSV-108
7" BJ-Style
(Original) Coupling Pin
W/ No Collar
WT. 0.64 LBS



CLIPS

& pins



PSV-111 Span Pin
WT. 0.10 LBS

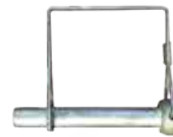

PSV-111S Square Span Pin
WT. 0.12 LBS



PSV-112 3-1/2" Toggle Pin
WT. 0.14 LBS



PSV-112S 2-1/2" Toggle Pin
WT. 0.10 LBS



PSV-113 Spring Clip
WT. 0.05 LBS



PSV-114 Pig Tail Pin
WT. 0.21 LBS



PSV-115 Roll Pin
WT. 0.04 LBS



PSV-118 Rivet Pin WT. 0.07 LBS
PSV-119 Cotter Pin WT. 0.01 LBS



PSV-129 J-Pin
WT. 0.56 LBS



ACCESSORIES

*From Cross Braces
to Outriggers
& More*



AERIAL TOOL & Bucket Tray

PSV-5002-00-BO
Aerial Tool & Bucket Tray
WT. 12.0 LBS



STVA ANGLE IRON Cross Braces

- PSV-374** 4' X 2' X 4' Angle Iron Cross Brace WT. 8.624 LBS
- PSV-350** 4' X 3' X 4' Angle Iron Cross Brace WT. 9.90 LBS
- PSV-351** 5' X 3' X 4' Angle Iron Cross Brace WT. 12.00 LBS
- PSV-352** 6' X 3' X 4' Angle Iron Cross Brace WT. 12.45 LBS
- PSV-353** 7' X 3' X 4' Angle Iron Cross Brace WT. 13.86 LBS
- PSV-354** 8' X 3' X 4' Angle Iron Cross Brace WT. 15.36 LBS
- PSV-365** 10' X 3' X 4' Angle Iron Cross Brace WT. 22.40 LBS

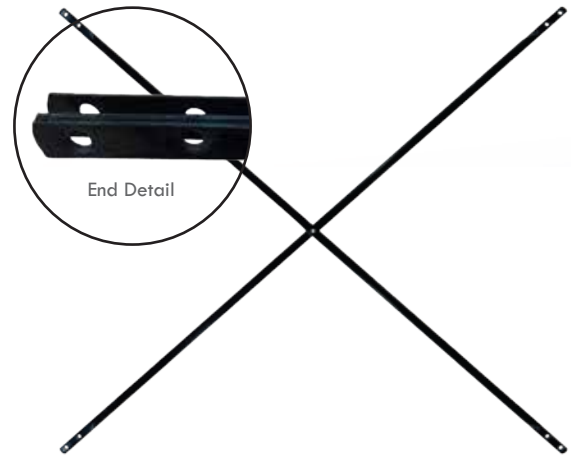

STVA TUBE Cross Braces

- PSV-300** 5' X 2' Tube Cross Brace WT. 8.00 LBS
- PSV-301** 7' X 2' Tube Cross Brace WT. 11.20 LBS
- PSV-302** 7' X 3' Tube Cross Brace WT. 11.20 LBS
- PSV-303** 7' X 4' Tube Cross Brace WT. 11.40 LBS
- PSV-304** 7' X 3' X 4' Tube Cross Brace WT. 11.00 LBS
- PSV-305** 10' X 4' Tube Cross Brace WT. 14.80 LBS
- PSV-306** 10' X 3' X 4' Tube Cross Brace WT. 14.60 LBS
- PSV-307** 10' X 2' Tube Cross Brace WT. 14.20 LBS
- PSV-308** 10' X 3' Tube Cross Brace WT. 15.00 LBS
- PSV-309** 7' X 1' Tube Cross Brace WT. 10.20 LBS
- PSV-310** 8' X 4' Tube Cross Brace WT. 12.34 LBS
- PSV-311** 7' X 42" Tube Cross Brace WT. 11.40 LBS
- PSV-312** 5' X 4' Tube Cross Brace WT. 9.30 LBS
- PSV-313** 6' X 4' Tube Cross Brace WT. 10.00 LBS
- PSV-314** 8' X 2' Tube Cross Brace WT. 11.60 LBS
- PSV-316** 8' X 3' X 4' Tube Cross Brace WT. 12.60 LBS
- PSV-317** 7' X 27-3/4" Tube Cross Brace WT. 11.80 LBS
- PSV-319** 10' X 27-3/4" Tube Cross Brace WT. 8.60 LBS
- PSV-320** 10' X 1' Tube Cross Brace WT. 13.60 LBS
- PSV-321** 4' X 4' Tube Cross Brace WT. 8.18 LBS
- PSV-325** 6' X 1' Tube Cross Brace WT. 8.80 LBS
- PSV-326** 6' X 2' Tube Cross Brace WT. 9.11 LBS
- PSV-327** 6' X 3' Tube Cross Brace WT. 10.38 LBS
- PSV-328** 5' X 1' Tube Cross Brace WT. 7.44 LBS
- PSV-329** 5' X 3' X 4' Tube Cross Brace WT. 9.42 LBS
- PSV-332** 7' X 5' Tube Cross Brace WT. 12.23 LBS
- PSV-333** 8' X 5' Tube Cross Brace WT. 13.60 LBS
- PSV-335** 4' X 3' X 4' Tube Cross Brace WT. 7.80 LBS
- PSV-339** 5' X 27-3/4" Tube Cross Brace WT. 8.07 LBS

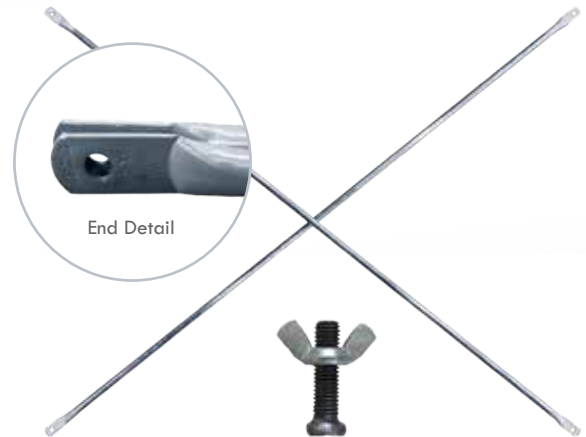

PSV-371N Wingnut Lock
for Hook on Angle Iron Braces
WT. 0.066 LBS

STVA DIAGONAL Goosers



- PSV-1200** 7' X 5' Diagonal Goosener WT. 10.80 LBS
- PSV-1201** 10' X 5' Diagonal Goosener WT. 14.20 LBS

STVA TUBE STRADDLE Braces



- PSV-1600**
7' X 4' Tube Straddle Braces
WT. 19.25 LBS
- PSV-1601**
10' X 4' Tube Straddle Braces
WT. 23.50 LBS



LOCKS *Replacement Parts*



PSV-120
Flip Lock
WT. 0.13 LBS



PSV-121
Drop Lock
WT. 0.13 LBS



PSV-122
Candy Cane Lock
WT. 0.51 LBS



PSV-123
BJ-Style C-Lock
WT. 0.84 LBS



PSV-124
V-Style Lock
WT. 0.60 LBS



LOCKING *Casters*



PSV-150
8" Locking Caster
W/ 1-3/8" Round Stem
WT. 10.97 LBS



PSV-151
5" Locking Caster
W/ 1-1/4" Square Stem
WT. 4.20 LBS



PSV-151R
5" Locking Caster
W/ 1-1/4" Round Stem
WT. 3.96 LBS



BASE *Plates*



PSV-141
1-3/8" Stem W/BJ-Style
5" X 5" Base Plate
WT. 1.91 LBS



PSV-160
1-7/16" Stem S/V Style
5" X 5" Base Plate
WT. 1.92 LBS



PSV-146A
6" X 6" W-Style
Swivel Base Plate
90° Angle
WT. 4.05 LBS



PSV-146B
6" X 6" S-Style
Swivel Base Plate
45° Angle
WT. 4.05 LBS



STVA
OUTRIGGER

PSV-215
30" Outrigger For
Frame Scaffold
WT. 18.80 LBS

STVA
BRACKETS



PSV-201
21" Tube Side Bracket
WT. 6.95 LBS



PSV-203B
21" Saddle Tube
Side Bracket
WT. 10.20 LBS



PSV-206C
20" Angle Iron End
Bracket W/Clamp
WT. 12.60 LBS



PSV-213
23" Angle Iron
Saddle Side Bracket
WT. 11.80 LBS



PSV-217
12" Tube
Side Bracket
WT. 5.40 LBS

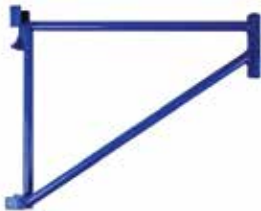

PSV-218
30" Tube
Side Bracket
WT. 10.20 LBS



PSV-228AB
20" - 30"
Round Tube
Expanding Side Bracket
WT. 14.10 LBS

STVA
WALL TIES

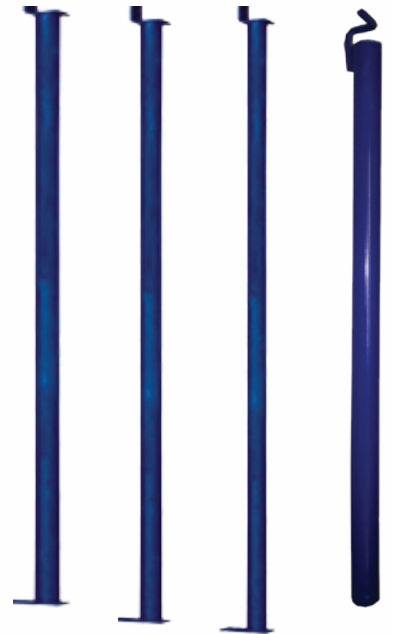

PSV-952 3' Tube Wall Tie WT. 5.20 LBS
PSV-953 4' Tube Wall Tie WT. 6.80 LBS
PSV-951 5' Tube Wall Tie WT. 7.80 LBS
PSV-956 3' Tube Wall Tie W/Hooks
WT. 6.20 LBS



INTERNAL Stair Units



PSV-919A & B Stair Unit Starter Bar WT. 9.00 LBS



PSV-917A & B 7' Top Rail For Internal Stair Unit
WT. 14.20 LBS



PSV-920A "Red" W-Style &
PSV-920AYW "Yellow" BJ-Style
Internal Stair Unit W/Handrails
(7' X 6'7" & 6'6")
WT. 114.80 LBS



PSV-920B
For S/V-Style Internal Stair
Unit W/Handrails
(7' X 6'4")
WT. 114.20 LBS



PSV-941B
For S/V-Style Internal Aluminum
Stair Unit W/Handrails
WT. 58 LBS

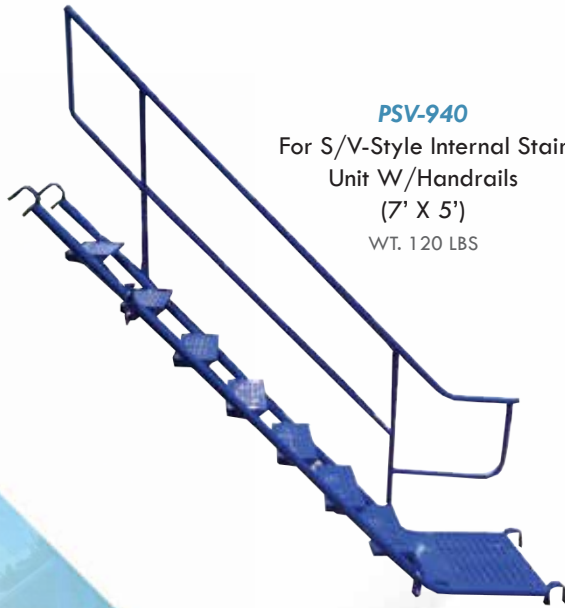

PSV-940
For S/V-Style Internal Stair
Unit W/Handrails
(7' X 5')
WT. 120 LBS



PSV-920RH
Rivet & Hitch Pin
For Stair Unit
WT. 0.20 LBS



PSV-920
Bolt Thumb Screw
For Stair Unit
WT. 0.10 LBS



PSV-925B
Rolling Tower Stair
Starter Step
WT. 22 LBS



STVA
LADDERS

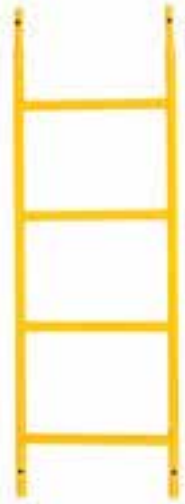

PSV-400 3' Ladder WT. 9.80 LBS

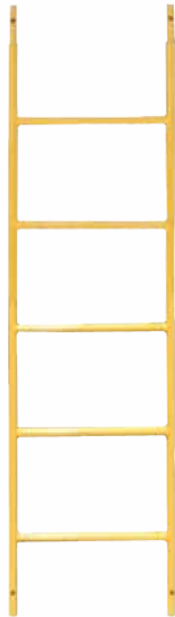

PSV-399 5' Ladder WT. 13.2 LBS

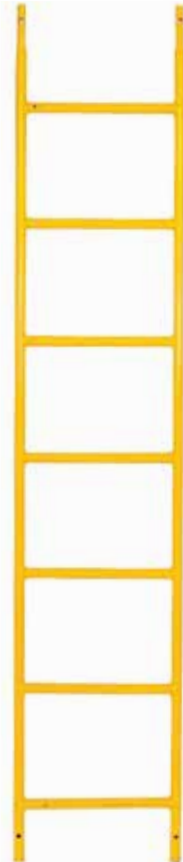

PSV-396 3' SAU Ladder WT. 9.44 LBS

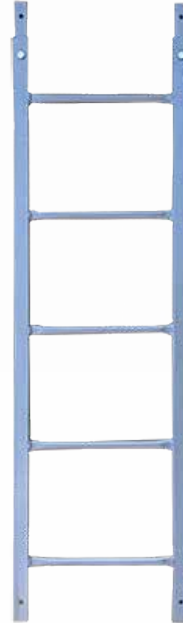

PSV-397 5' SAU Ladder WT. 16.17 LBS

PSV-401 6' Ladder WT. 16.04 LBS

PSV-395 6' SAU Ladder WT. 18.12 LBS

STVA
LADDER Brackets



PSV-960
Bolt-On Ladder Bracket
WT. 5.6 LBS



PSV-200
Ladder Bracket
WT. 6.0 LBS



PSV-959
SAU Ladder Bracket
WT. 5.54 LBS

STVA
PANELS

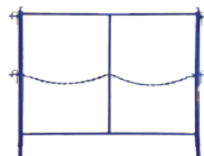

PSV-525CC
S/V Access Panel
For Mason Frame
WT. 27.43 LBS



PSV-524B
Expandable
"P" Panel
WT. 11.80 LBS

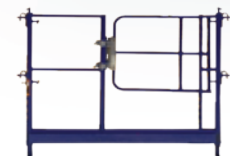

PSV-528
S/V Style Access Panel
W/Swing Gate
WT. 63 LBS

STVA
GUARD RAIL PANELS & Gates



PSV-519N
 3'/42" End Panel
 WT. 8.20 LBS



PSV-520N 5' End Panel
 WT. 9.6 LBS (48.98"W X 21"H)

PSV-520W 5' End Panel
 WT. 10.4 LBS (52"W X 21"H)

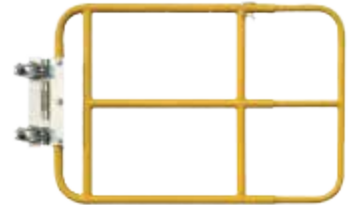

PSV-800N
 3' Expandable Access Gate
 WT. 22.40 LBS



PSV-521N
 7' Guard Rail Side Panel
 WT. 13.40 LBS



PSV-522
 10' Guard Rail Side Panel
 WT. 25.43 LBS



PSV-520W632
 End Panel For 5' X 6' 7"
 Walk-Thru Frame
 WT. 10.01 LBS

STVA
GUARD Rails



- PSV-507** 2' Guard Rail WT. 1.60 LBS
- PSV-500** 3' Guard Rail WT. 2.20 LBS
- PSV-501** 42" Guard Rail WT. 2.60 LBS
- PSV-505** 4' Guard Rail WT. 3.00 LBS
- PSV-502** 5' Guard Rail WT. 3.60 LBS
- PSV-503** 7' Guard Rail WT. 5.20 LBS
- PSV-506** 8' Guard Rail WT. 8.14 LBS
- PSV-504** 10' Guard Rail WT. 10.0 LBS



PLANKS & Decking



DI-65 Southern Yellow Pine Plank
Available In The Following Sizes:

PSV-MSR-2208 8' Wood Plank - Blue - WT. 32.2 LBS

PSV-MSR-2210 10' Wood Plank - Red - WT. 39 LBS

PSV-MSR-2212 12' Wood Plank - Yellow - WT. 46.8 LBS

PSV-MSR-2216 16' Wood Plank - Green - WT. 62.4 LBS

STVA wooden planks are all color coded on the ends for easy length recognition.



PSV-SP-03 3' X 9" Raised Hook Steel Plank WT. 12.10 LBS

PSV-SP-036 3'-6" X 9" Raised Hook Steel Plank WT. 13.30 LBS

PSV-SP-04 4' X 9" Raised Hook Steel Plank WT. 16.50 LBS

PSV-SP-05 5' X 9" Raised Hook Steel Plank WT. 20.20 LBS

PSV-SP-06 6' X 9" Raised Hook Steel Plank WT. 24.20 LBS

PSV-SP-07 7' X 9" Raised Hook Steel Plank WT. 27.50 LBS

PSV-SP-08 8' X 9" Raised Hook Steel Plank WT. 33.00 LBS

PSV-SP-09 9' X 9" Raised Hook Steel Plank WT. 35.50 LBS

PSV-SP-10 10' X 9" Raised Hook Steel Plank WT. 38.00 LBS



PSV-W-11603 3' X 9" Flat Hook Steel Plank WT. 13.75 LBS

PSV-W-1160 3'-6" X 9" Flat Hook Steel Plank WT. 14.75 LBS

PSV-W-1161 4' X 9" Flat Hook Steel Plank WT. 17.60 LBS

PSV-W-1162 5' X 9" Flat Hook Steel Plank WT. 21.90 LBS

PSV-W-1163 6' X 9" Flat Hook Steel Plank WT. 24.90 LBS

PSV-W-1164 7' X 9" Flat Hook Steel Plank WT. 28.00 LBS

PSV-W-1165 8' X 9" Flat Hook Steel Plank WT. 34.50 LBS

PSV-W-1166 9' X 9" Flat Hook Steel Plank WT. 37.00 LBS

PSV-W-1167 10' X 9" Flat Hook Steel Plank WT. 39.60 LBS



PSV-1108

7' X 28" Aluminum Hatch Deck
WT. 60 LBS

PSV-1110

10' X 28" Aluminum Hatch Deck
WT. 72.8 LBS



PSV-1115

7' X 12" Aluminum Filler Board
WT. 19.36 LBS

PSV-1116

10' X 12" Aluminum Filler Board
WT. 26.40 LBS



PSV-1105

Aluminum Board
Replacement Hooks
WT. 0.40 LBS



PSV-1100 7' X 19" Alum/Plywood Deck WT. 35.10 LBS

PSV-1104 10' X 19" Alum/Plywood Deck WT. 51.00 LBS



PSV-1100-02 7' X 19" Ply/Wood Replacement Deck WT. 13.7 LBS

PSV-1104-02 10' X 19" Ply/Wood Replacement Deck WT 20.83 LBS



PSV-1106 5' X 19" Aluminum Board WT. 25.00 LBS

PSV-1101 7' X 19" Aluminum Board WT. 30.00 LBS

PSV-1103 10' X 19" Aluminum Board WT. 39.00 LBS

STVA
GUARD RAIL
Posts



PSV-530AC
 42" W-Style
 Female Corner Guard
 Rail Post (Red) 90° Hole
 (Candy Cane Lock)
 WT. 7.70 LBS



PSV-530AF
 BJ-Style Female
 Corner Guard
 Rail Post (Yellow)
 90° Hole
 WT. 6.18 LBS



PSV-530BC
 Female Guard
 Rail Post (Blue)
 45° Hole
 (Candy Cane Lock)
 WT. 7.7 LBS



PSV-530BF
 Female Corner Guard
 Rail Post 45° Hole
 (Flip Lock)
 WT. 6.02 LBS



PSV-537AN
 42" W-Style
 Rail Post W/ Kicker
 (Blue) 90° Hole
 (Candy Cane Lock)
 WT. 8.30 LBS



PSV-537AR
 42" W-Style
 Rail Post W/ Kicker
 (Red) 90° Hole
 (Candy Cane Lock)
 WT. 8.30 LBS



PSV-540A
 Male Guard Rail Post
 W/ 90° Hole
 (Flip Lock)
 WT. 5.22 LBS



PSV-540B
 Male Guard Rail Post
 W/ 45° Hole
 (Flip Lock)
 WT. 5.22 LBS





PUTLOGS



PSV-750 8' Putlog (Truss) WT. 27.60 LBS

PSV-751 12' Putlog (Truss) WT. 42.20 LBS



PSV-752 16' Putlog (Truss) WT. 62.40 LBS

PSV-755 22' Putlog (Truss) WT. 86.57 LBS



PSV-756 5' Putlog Spreader WT. 24.2 LBS



PSV-760

Parallel Putlog Hanger

WT. 4.40 LBS



PSV-761

Right Angle Putlog Hanger

WT. 5.00 LBS



PSV-656A

Saddle Pin

WT. 2.13 LBS



PSV-656B

Saddle Pin

WT. 2.13 LBS



SCAFFOLD TAGS



PSV-Tag-Stop

Stop Tags
(Package of 25)



PSV-Tag-OK

OK (Safe For Use) Tags
(Package of 25)



PSV-Tag-Caution

Caution Tags
(Package of 25)



PSV-Tag-Pouch

Clear Pouch
(Package of 25)



STORAGE & SHIPPING Rack & Basket



PSV-4200

Stackable Storage Rack

WT. 123.46 LBS



PSV-4201

Collapsible Storage Basket

WT. 75.20 LBS

STVA
SCREW
Jacks



PSV-171
1-1/4" Screw Jack
W/Swivel Base Plate
WT. 14.0 LBS



PSV-164
1-3/8" Swivel
Screw Jack
WT. 14.80 LBS



PSV-140
24" Extension
Base Plate
WT. 4.20 LBS



PSV-130
1-3/8" Socket Jack
WT. 10.40 LBS



PSV-130S
1-1/2" Socket Jack
WT. 8.20 Lbs



PSV-134
1-3/8" X 24"
Screw Jack
W/Base Plate
WT. 11.40 LBS



PSV-131
1-1/4" X 24"
Screw Jack
W/ Base Plate
WT. 10.40 LBS

STVA
CONCRETE FORMING
Accessories



PSV-1350
Forming Turnbuckle
Flat Plate
WT. 7.40 LBS



PSV-1351
Forming Turnbuckle
Bent Plate
WT. 8.00 LBS



PSV-110
Wedge Bolt
WT. 0.20 LBS



PSV-181
1/2" Coil & Nut Bolt
WT. 0.20 LBS

STVA
HOIST ARMS
 & Well Wheels



PSV-3001
 10" Well Wheel
 Depth of Well 1"
 Comes In Zinc or Red
 WT. 9.60 LBS

PSV-3002
 12" Well Wheel
 Depth of Well 1"
 WT. 15.4 LBS

PSV-3000A
 W-Style
 Hoist Arm
 WT. 29.85 LBS

PSV-3000B
 S-Style
 Hoist Arm
 WT. 29.99 LBS



STVA
FOLDING
 A-Frames



PSV-1400 3' Folding A Frame WT. 22.40 LBS

PSV-1401 4' Folding A Frame WT. 32.00 LBS

PSV-1402HD 6' Folding A Frame WT. 49.00 LBS

STVA **STANCHIONS**



PSV-535
 Guard Rail Stanchion
 WT. 24.80 LBS



PSV-538
 Guard Rail Stanchion
 Square Tube
 WT. 20.60 LBS

STVA **MORTAR Stands**



PSV-1501 20" X 30" Mortar Stand WT. 17.00 LBS

STVA **MORTAR Tubs**



PSV-1530
 10 Gauge Steel
 Mortar Tub
 WT. 173.8 LBS

PSV-1531
 14 Gauge Steel
 Mortar Tub
 WT. 117.7 LBS

STVA **VENEER Jacks**

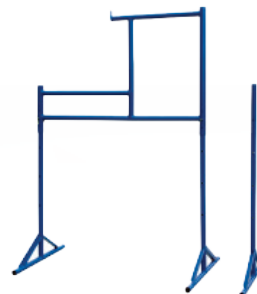

PSV-470 Veneer Jack Frames WT. 17.20 LBS

PSV-471 Veneer Jack Legs WT. 8.80 LBS

STVA
MULTI-PURPOSE
/Interior Scaffolding



PSV-2000 Steel Multi-Purpose Unit (Yellow) WT. 150 LBS
PSV-1999 Steel Multi-Purpose Unit W/Hatch Deck (Yellow) WT. 150 LBS



PSV-2002 Aluminum Multi-Purpose Unit WT. 90.00 LB



PSV-2000-5 Multi-Purpose Hatch Deck WT. 31.24 LBS



PSV-2001 Steel Guard Rail Assembly WT. 89 LBS



PSV-2003 Aluminum Guard Rail Assembly WT. 32.6 LBS



PSV-208
 30" Steel Outrigger
 For MPU
 WT. 18.20 LBS



PSV-207
 18" Steel Outrigger
 For MPU
 WT. 5.8 LBS



PSV-151
 5" Locking Caster
 W/ 1-1/4" Square Stem
 WT. 4.20 LBS



PSV-141MPU
 Multi-Purpose 5" X 5"
 Base Plate
 WT. 2.02 LBS



STVA
TUBE & CLAMP
Scaffold



PSV-131N
 Base Plate
 W/ Tube Lock
 WT. 3.20 LBS



- PSV-909G** 2' Tube W/End Fitting WT. 6.03 LBS
- PSV-910G** 4' Tube W/End Fitting WT. 11.80 LBS
- PSV-911G** 6' Tube W/End Fitting WT. 16.60 LBS
- PSV-912G** 8' Tube W/End Fitting WT. 20.20 LBS
- PSV-913G** 10' Tube W/End Fitting WT. 26.20 LBS
- PSV-914G** 13' Tube W/End Fitting WT. 48.80 LBS
- PSV-916G** 16' Tube W/End Fitting WT. 37.95 LBS
- PSV-915G** 20' Tube W/End Fitting WT. 40.00 LBS
- PSV-938G** 24' Tube W/End Fitting WT. 48.40 LBS

STVA
SCAFFOLD
Clamps

All 2" clamps can be ordered with I-Bolt or T-Bolt



PSV-771
 3-1/2" X 2"
 Swivel Clamp
 WT. 5.40 LBS



PSV-772
 3-1/2" X 2" Right
 Angle Clamp
 WT. 5.94 LBS



PSV-773
 3-1/2" Stud Clamp
 WT. 4.20 LBS



PSV-900
 2" X 2" Swivel Clamp
 WT. 3.86 LBS



PSV-901
 Right Angle Clamp
 WT. 3.22 LBS



PSV-902
 Rigid Beam Clamp
 WT. 3.20 LBS



PSV-902S
 Swivel Beam Clamp
 WT. 3.40 LBS



PSV-904
 Half Clamp
 WT. 1.80 LBS



PSV-905
 2-1/2" X 2"
 Swivel Clamp
 WT. 5.40 LBS



PSV-906
 2-1/2" X 2" Right
 Angle Clamp
 WT. 5.00 LBS



PSV-907N
 2" Stud Clamp
 WT. 1.67 LBS



H.L. 10K SHORING Frames

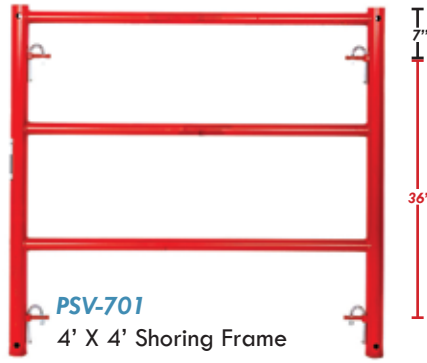

PSV-701
4' X 4' Shoring Frame
WT. 48.80 LBS

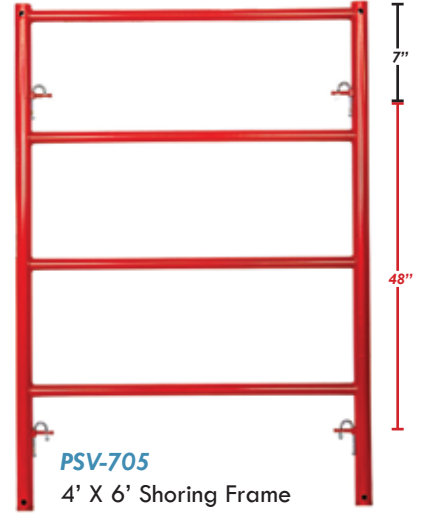

PSV-705
4' X 6' Shoring Frame
WT. 65.20 LBS

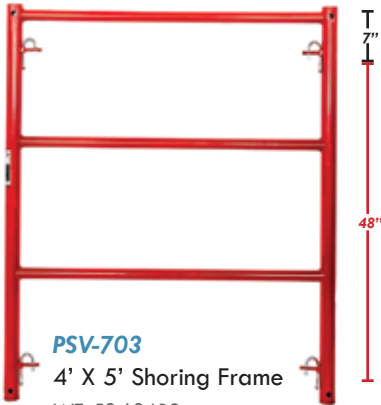

PSV-703
4' X 5' Shoring Frame
WT. 52.60 LBS

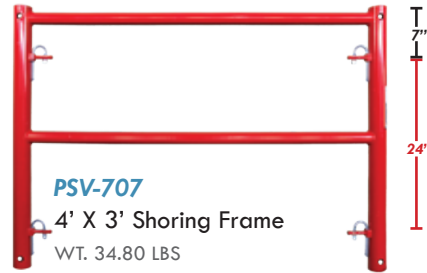

PSV-707
4' X 3' Shoring Frame
WT. 34.80 LBS

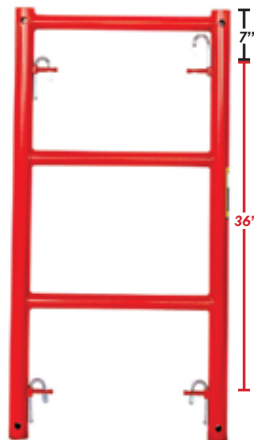

PSV-702
2' X 4' Shoring Frame
WT. 38.20 LBS



PSV-704
2' X 5' Shoring Frame
WT. 45.40 LBS

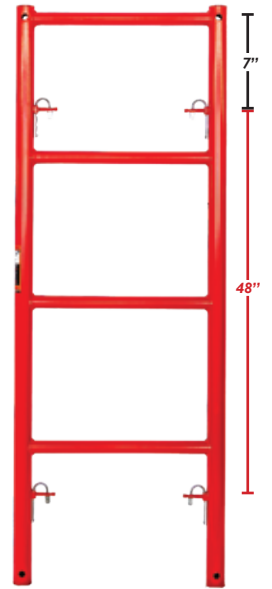

PSV-706
2' X 6' Shoring Frame
WT. 53.40 LBS

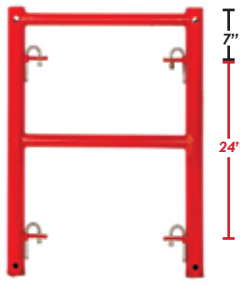

PSV-708
2' X 3' Shoring Frame
WT. 28.00 LBS

- Uses PSV-102
- Standard Color RED
- First Lock 7" From Top of Frame Leg (13" on 6' Tall Frames)
- Candy Cane Locking System
- 2.375" O.D. Tube Diameter X 0.148" Wall Thickness



PSV-133N
1-7/8" X 36" Shoring
Screw Jack
WT. 10.20 LBS



PSV-133N-02
Forged Wing Nut
For Hollow Jack
WT. 2.00 LBS



PSV-105A
1-3/8" X 1-7/8"
Shoring to W-Style
Coupling Pin
WT. 1.17 LBS



PSV-105B
1-7/16" X 1-7/8"
Shoring to S-Style
Coupling Pin
WT. 1.17 LBS



PSV-102
1-7/8" H.L. Shoring
Connector
WT. 0.96 LBS



25K SHORING Frames

- Uses PSV-55100
- Standard Color RED
- Candy Cane Locking System
- 3" Square Tube Diameter X 3/16" Wall Thickness

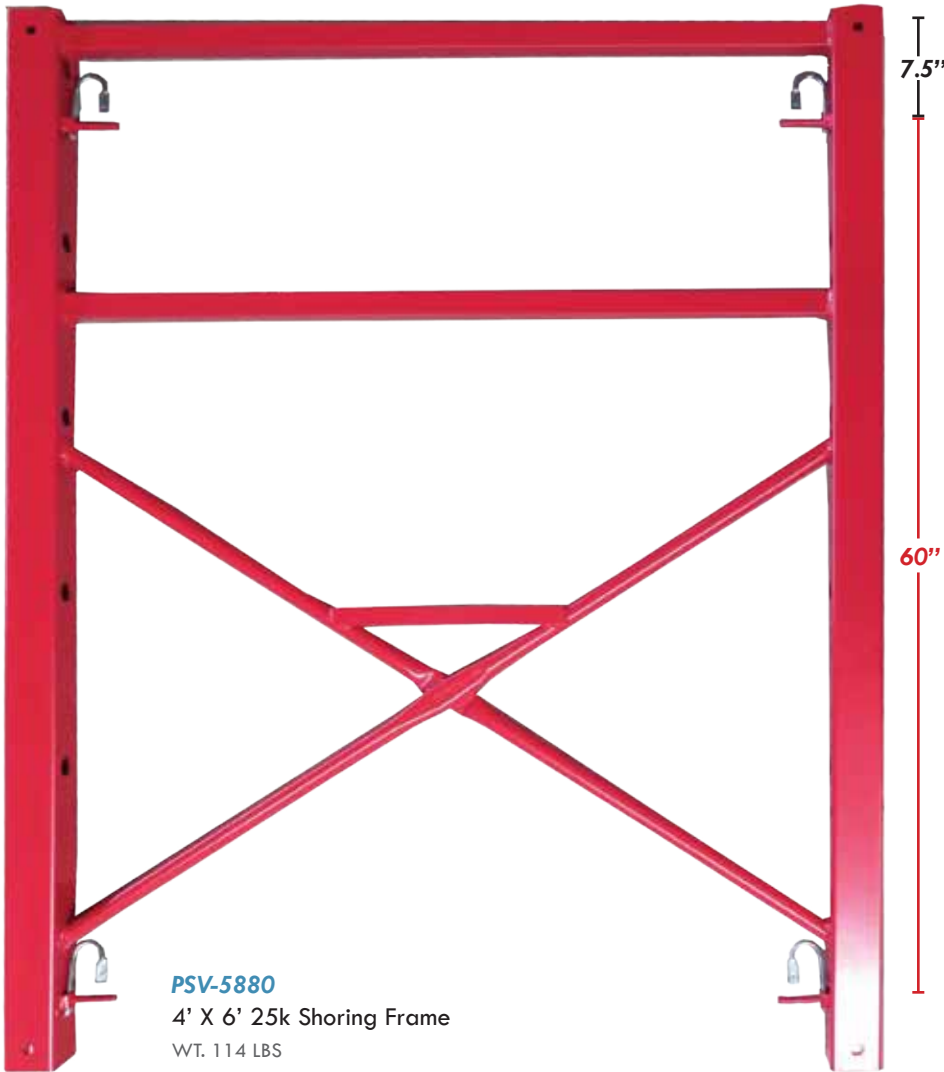
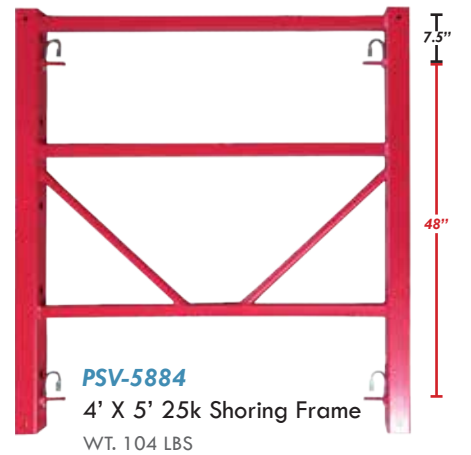
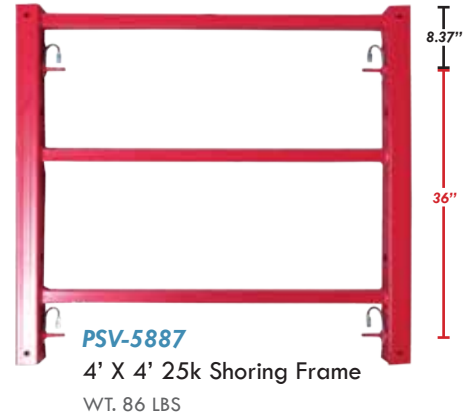

PSV-5142
25k Shoring Insert
WT. 4.4 LBS



PSV-55100
25k Shoring
Alignment Pin
WT. 3.3 LBS



PSV-5200
25k Solid
Bar Shoring
Screw Jacks
WT. 27.19 LBS



PSV-55099
25k Shoring
Adaptor Pin
WT. 3.1 LBS



PSV-5102
Nailing Plate For
25k Frame Leg
WT. 2.31 LBS

STVA
10-25K SHORING
 Accessories



Small 2.4mm



Medium 3.8mm



Large 4.5mm

PSV-117B Large Hitch Pin WT 0.05 LBS

PSV-117M Medium Hitch Pin WT 0.04 LBS

PSV-117S Small Hitch Pin WT 0.01 LBS



PSV-908A

#1 A-Clamp Assembly
(Steel)

WT. 0.50 LBS



PSV-908AN

#1 A-Clamp Assembly (Steel)
Bolt & Nut

WT. 0.29 LBS



PSV-908B

#2 A-Clamp Assembly
(Aluminum)
Bolt, Nut & Washer (Steel)

WT. 0.31 LBS



PSV-908BNW

#2 A-Clamp Assembly
Bolt, Nut & Washer (Steel)

WT. 0.18 LBS



PSV-2611

#2 C-Clamp W/
3/4" Opening

WT. 0.35 LBS



PSV-2611B

#2 C-Clamp W/ 1" Opening

WT. 0.38 LBS



PSV-116

3" X 5/8" Drilled Rivet

WT. 0.34 LBS



PSV-129

J-PIN

WT. 0.56 LBS



10K NOMINAL RANGE

Post Shores

2.375" O.D. Post Shore, 1.9" O.D. Staff Post.
(Available powder coated black or galvanized.)



PSV-718 (#0)
3'6" to 6'
Post Shore
WT. 30.53 LBS



PSV-719 (#1)
5'9" to 10'3"
Post Shore
WT. 39.24 LBS



PSV-720 (#2)
6'6" to 11'
Post Shore
W/ Or W/Out U-Head
WT. 47.72 LBS



PSV-721 (#3)
8'6" to 13'
Post Shore
WT. 53.45 LBS



PSV-722 (#4)
10'6" to 16'
Post Shore
WT. 63.16 LBS



PSV-121N
Threaded Drop Lock
WT. 0.24 LBS



25K NOMINAL RANGE

Post Shores

3" O.D. Post Shore, 2.50" O.D. Staff Post.
(Available powder coated black or galvanized.)



PSV-724G
5'7" to 9'6"
Galvanized
25k Post Shore
WT. 51.71 LBS



PSV-729G
6'6" to 11'6"
Galvanized
25k Post Shore
WT. 61.0 LBS



PSV-733G
10' to 18'
Galvanized
25k Post Shore
WT. 88.4 LBS



STVA Post Shores now have threaded weld nuts welded on the outer tube. These Threaded Weld Nuts (PSV-121N-03) accept Threaded Drop Locks (PSV-121N) that self support Post Shore structures on your job site, as shown in the example above. PSV-121N Threaded Drop Locks are sold separately.

STVA
10-25K SHORING
Accessories



PSV-143
 7" X 7" Shoring Base Plate
 For Shoring Jack
 WT. 6.05 LBS



PSV-142
 7" X 9" Shoring Base Plate
 For Shoring Jack
 WT. 7.57 LBS



PSV-149
 7" X 7" Shoring Base Plate
 For Frame Leg
 WT. 6.20 LBS



PSV-156
 5" X 8" Shoring J-Head
 For Shoring Jack
 WT. 7.60 LBS



PSV-144
 8" X 8" Shoring U-Head
 For Shoring Jack
 WT. 12.60 LBS



PSV-147
 8" X 9" Shoring U-Head
 For Shoring Jack
 WT. 13.60 LBS



PSV-157
 8" X 10" Shoring U-Head
 For Shoring Jack
 WT. 14.00 LBS



PSV-172
 4" X 8" U-Head for
 Scaffold Frame
 WT. 5.10 LBS



PSV-145
 8" X 8" Shoring
 Base Plate
 WT. 7.96 LBS



PSV-158
 5" X 7" 10k Post Shore
 U-Head
 WT. 8.60 LBS



PSV-5144
 25k Post Shore U-Head
 WT. 10.01 LBS



STVA
10-25K SHORING
Accessories



PSV-126
 Nailing Plate For
 10k Frame Leg
 WT. 1.21 LBS



PSV-5103
 Post Shore Spring Clip
 WT. 0.15 LBS



PSV-143S
 6" X 6" 10k Shoring
 Swivel Base Plate
 WT. 4.73 LBS



PSV-720-03
 Post Shore Nut
 For 6'-11' Post Shore
 WT. 2.60 LBS



PSV-191
 Post Shore Handle
 WT. 1.41 LBS



PSV-180
 Reshore Clip
 WT. 0.03 LBS

STVA
A-BEAM
Aluminium Beam/Joist



PSV-1144106 10' X 6.5" A-Beam WT. 43 LBS

PSV-114412 12' X 6.5" A-Beam WT. 49 LBS

PSV-114414 14' X 6.5" A-Beam WT. 57 LBS

PSV-114416 16' X 6.5" A-Beam WT. 66 LBS

PSV-114418 18' X 6.5" A-Beam WT. 74 LBS

PSV-114421 21' X 6.5" A-Beam WT. 86 LBS

STVA
25K SHORING
 Accessories



PSV-5117
 25k Adapter Pin Hitch Pin
 WT. 0.08 LBS



PSV-5129
 25k Alignment J-Pin
 WT. 0.77 LBS



PSV-5160
 25k Screw Jack
 with 8 X 8 U-Head
 WT. 20 LBS

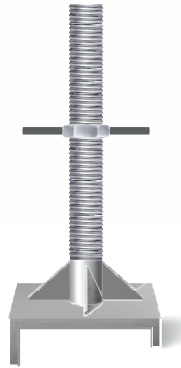

PSV-5161
 25k Screw Jack with
 6 X 6 X .500 J-Head
 WT. 14.64 LBS



PSV-5162
 25k Screw Jack with
 6 X 6 X .500 U-Head
 WT. 15.65 LBS



PSV-5201
 25k 8 X 9 Screw Jack
 with U-Head
 WT. 35 LBS



PSV-5950
 25k 12" Bar Brace
 WT. 0.66 LBS



PSV-5141
 25k Frame Extension
 WT. 21.56 LBS



SYSTEM

Scaffold Equipment

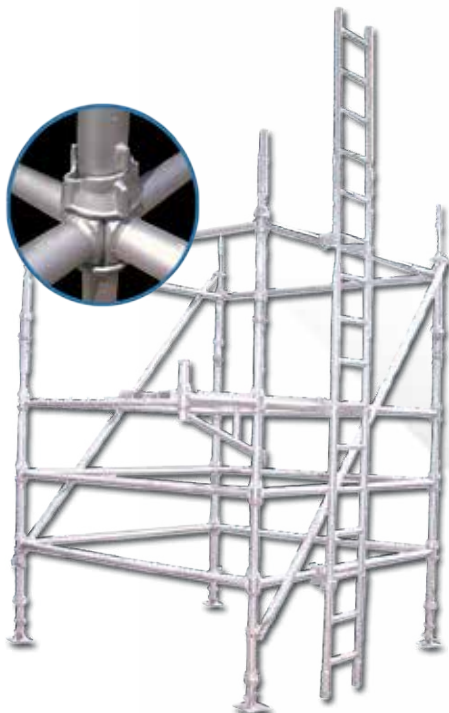

TABLE OF CONTENTS

Ring Lock Standards with Spigot	37
Ring Lock Board Brackets	37
Ring Lock Ledgers	38
Ring Lock Truss Ledgers	39
Ring Lock Lattice Girder	39
Ring Lock Double Ledgers	39
Ring Lock Vertical/Diagonals/Bay Brace	40
Ring Lock Swivel Clamp Horizontal Diagonal Brace	40
Ring Lock Ladders & Brackets	41
System Equipment Screw Jacks	41
System Equipment Starter Collars	41
System Equipment Accessories	42-43
Cup Lock Verticals/Standards	44
Cup Lock Horizontal Ledgers	45
Cup Lock Double Ledgers	45
Cup Lock Trussed Ledger	46
Cup Lock Bay Brace/Face Brace	46
Cup Lock Board Brackets	46
Cup Lock Ladders & Brackets	47



RING Lock



CUP Lock

STVA RING LOCK Standards with Spigots

The Ring Lock System can accommodate up to eight connections of combined ledgers and braces. Each of these connections can safely carry a load of 5,000 lbs. (11.12kN)

However, the total sum of the ledger loads MUST NOT exceed the recommended leg load for any given bracing situation.

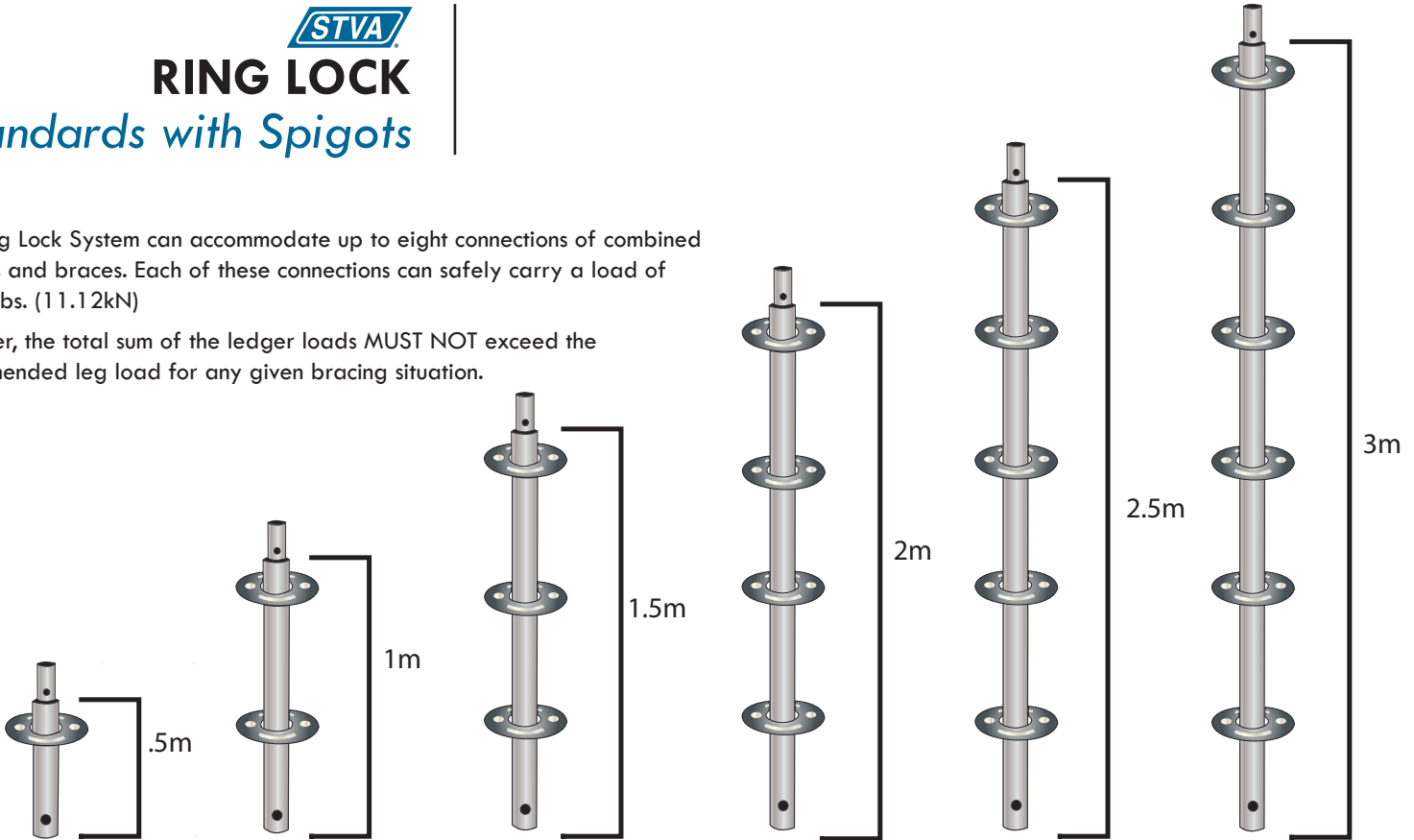

STVA Product No.	Product Description	Weight	Dimension
PSV-RL-9105	0.5m Standard - Vertical W/Spigot 1-Ring	6.49 LBS	1' 7-11/16"
PSV-RL-9110	1.0m Standard - Vertical W/Spigot 2-Ring	11.44 LBS	3' 3-3/8"
PSV-RL-9115	1.5m Standard - Vertical W/Spigot 3-Ring	16.41 LBS	4' 11-1/16"
PSV-RL-9120	2.0m Standard - Vertical W/Spigot 4-Ring	21.36 LBS	6' 6-47/64"
PSV-RL-9125	2.5m Standard - Vertical W/Spigot 5-Ring	26.33 LBS	8' 2-27/64"
PSV-RL-9130	3.0m Standard - Vertical W/Spigot 6-Ring	31.5 LBS	9' 10-7/64"

STVA RING LOCK Board Brackets

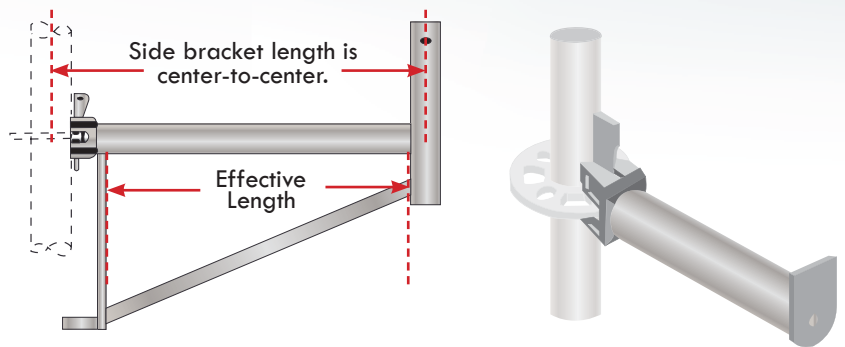

STVA Product No.	Product Description	Weight	Dimension	Effective Length
PSV-RL-9601N	1 Board Side Bracket - 12"	9.61 LBS	12.60"	9.47"
PSV-RL-9602	2 Board Side Bracket W/Spigot-24"	14.27 LBS	25.59"	21.81"
PSV-RL-9603	3 Board Side Bracket W/Spigot-34"	18.67 LBS	34.65"	30.81"

STVA
RING LOCK
Ledgers

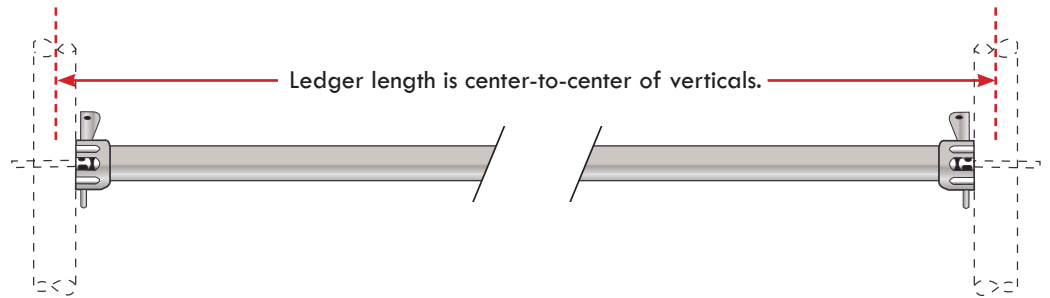

STVA Product No.	Product Description	Weight	Dimension
<i>PSV-RL-9210</i>	1' Single Ledger (0.305m)	2.6 LBS	12"
<i>PSV-RL-9216</i>	1' 6" Single Ledger (0.457m)	5.5 LBS	1' 6"
<i>PSV-RL-9220</i>	2' Single Ledger (0.609m)	6 LBS	2'
<i>PSV-RL-9222</i>	2' 2" Single Ledger (0.660m)	6.4 LBS	2' 2"
<i>PSV-RL-9224</i>	2' 4" Single Ledger (0.711m)	7.30 LBS	2' 4"
<i>PSV-RL-9226</i>	2' 6" Single Ledger (0.762m)	7.5 LBS	2' 6"
<i>PSV-RL-9230</i>	3' Single Ledger (0.914m)	8.93 LBS	3'
<i>PSV-RL-9236</i>	3' 6" Single Ledger (1.066m)	10.14 LBS	3' 6"
<i>PSV-RL-92310</i>	3' 10" Single Ledger (1.168m)	11 LBS	3' 10"
<i>PSV-RL-9240</i>	4' Single Ledger (1.219m)	11.35 LBS	4'
<i>PSV-RL-9243</i>	4' 3" Single Ledger (1.295m)	12.61 LBS	4' 3"
<i>PSV-RL-92411</i>	4' 11" Single Ledger (1.498m)	14.3 LBS	4' 11"
<i>PSV-RL-9250</i>	5' Single Ledger (1.524m)	13.77 LBS	5'
<i>PSV-RL-9252</i>	5' 2" Single Ledger (1.572m)	14.94 LBS	5' 2"
<i>PSV-RL-9254</i>	5' 4" Single Ledger (1.625m)	15.36 LBS	5' 4"
<i>PSV-RL-9260</i>	6' Single Ledger (1.828m)	16.19 LBS	6'
<i>PSV-RL-9269</i>	6' 9-1/2" Single Ledger (2.057m)	18.03 LBS	6' 9-1/2"
<i>PSV-RL-9270</i>	7' Single Ledger (2.133m)	18.61 LBS	7'
<i>PSV-RL-9280</i>	8' Single Ledger (2.438m)	21.03 LBS	8'
<i>PSV-RL-9285</i>	8' 5" Single Ledger (2.565m)	23.19 LBS	8' 5"
<i>PSV-RL-9286</i>	8' 6" Single Ledger (2.590m)	22.24 LBS	8' 6"
<i>PSV-RL-9290</i>	9' Single Ledger (2.743m)	23.98 LBS	9'
<i>PSV-RL-92100</i>	10' Single Ledger (3.048m)	26.99 LBS	10'
<i>PSV-RL-92101</i>	10' 1" Single Ledger (3.073m)	26.15 LBS	10' 1"
<i>PSV-RL-9612</i>	2 Board Bracket Ledger For Side Bracket (0.649m)	5.72 LBS	25.59"
<i>PSV-RL-9613</i>	3 Board Bracket Ledger For Side Bracket (0.879m)	7.72 LBS	34.64"

STVA
RING LOCK
Truss Ledgers

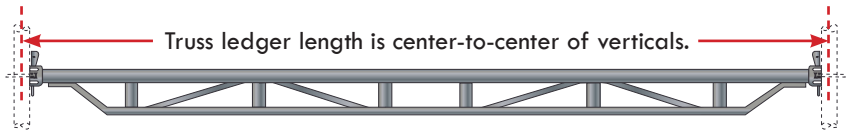

STVA Product No.	Product Description	Weight	Dimension
PSV-RL-9505	5' Truss Ledger (1.524m)	22.55 LBS	5'
PSV-RL-9506	6' Truss Ledger (1.828m)	27.25 LBS	6'
PSV-RL-9507	7' Truss Ledger (2.133m)	30.51 LBS	7'
PSV-RL-9508	8' Truss Ledger (2.438m)	39.99 LBS	8'
PSV-RL-9509	9' Truss Ledger (2.743m)	43.02 LBS	9'
PSV-RL-9510	10' Truss Ledger (3.048m)	46.04 LBS	10'
PSV-RL-9512	12' Truss Ledger (3.657m)	55.97 LBS	12'
PSV-RL-9514	14' Truss Ledger (4.267m)	65.27 LBS	14'
PSV-RL-9516	16' Truss Ledger (4.876m)	74.47 LBS	16'
PSV-RL-9520	20' Truss Ledger (6.096m)	94.05 LBS	20'

STVA
RING LOCK
Lock Lattice Girders

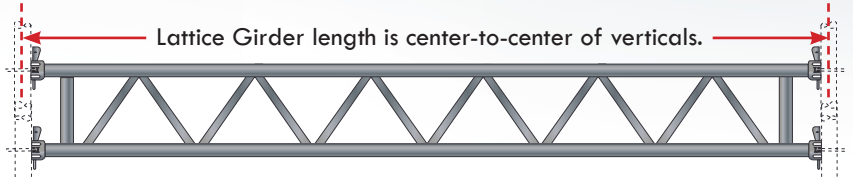

STVA Product No.	Product Description	Weight	Dimension
PSV-RL-9807	7' Lattice Girder (2.133m)	61.8 LBS	7'
PSV-RL-9810	10' Lattice Girder (3.048m)	83.9 LBS	10'
PSV-RL-9814	14' Lattice Girder (4.627m)	111.8 LBS	14'
PSV-RL-9816	16' Lattice Girder (4.876m)	125.5 LBS	16'
PSV-RL-9818	18' Lattice Girder (5.486m)	139.3 LBS	18'
PSV-RL-9820	20' Lattice Girder (6.096m)	153.1 LBS	20'
PSV-RL-9821	21' Lattice Girder (6.400m)	154.1 LBS	21'
PSV-RL-9828	28' Lattice Girder (8.543m)	219.3 LBS	28'

STVA
RING LOCK
Double Ledgers

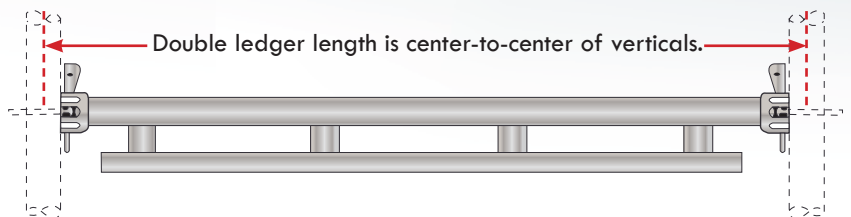

STVA Product No.	Product Description	Weight	Dimension
PSV-RL-9505N	5' Double Ledger (1.524m)	27.5 LBS	5'
PSV-RL-9506N	6' Double Ledger (1.828m)	31.2 LBS	6'
PSV-RL-9507N	7' Double Ledger (2.133m)	34.5 LBS	7'
PSV-RL-9508N	8' Double Ledger (2.438m)	40.7 LBS	8'
PSV-RL-9509N	9' Double Ledger (2.743m)	46.5 LBS	9'
PSV-RL-9510N	10' Double Ledger (3.048m)	51.7 LBS	10'

STVA RING LOCK Vertical/Diagonals/Bay Brace

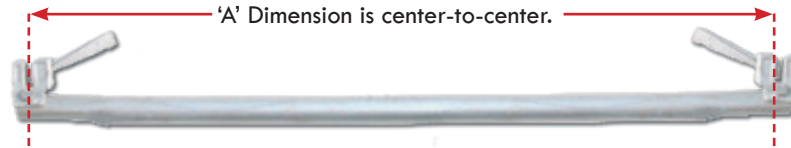

STVA Product No.	Product Description	Weight	Effective Working Dims	'A' Dimension
PSV-RL-9316	1' Vertical Diagonals/Bay Brace	14.82 LBS	39.37"BW X 59.10"HT (1m X 1.50m)	67.3"
PSV-RL-93246	2' 4" Vertical Diagonals/Bay Brace	17.09 LBS	28"BW X 78.74"HT (0.711m X 2m)	81.47"
PSV-RL-9336	3' Vertical Diagonals/Bay Brace	17.53 LBS	36"BW X 78.74"HT (0.914m X 2m)	83.88"
PSV-RL-93366	3' 6" Vertical Diagonals/Bay Brace	17.89 LBS	42" X 78.74"HT (1.066m X 2m)	86.13"
PSV-RL-9346	4' Vertical Diagonals/Bay Brace	13.91 LBS	48"BW X 78.74"HT (1.22m X 2m)	88.73"
PSV-RL-93436	4' 3" Vertical Diagonals/Bay Brace	18.48 LBS	51"BW X 78.74"HT (1.295m X 2m)	90.15"
PSV-RL-934116	4' 11" Vertical Diagonals/Bay Brace	19.14 LBS	59"BW X 78.74"HT (1.500m X 2m)	94.34"
PSV-RL-9356	5' Vertical Diagonals/Bay Brace	24.35 LBS	60"BW X 78.74"HT (1.524m X 2m)	96.61"
PSV-RL-93526	5' 2" Vertical Diagonals/Bay Brace	19.40 LBS	62"BW X 78.74"HT (1.574m X 2m)	96"
PSV-RL-9366	6' Vertical Diagonals/Bay Brace	0.90 LBS	72"BW X 78.74"HT (1.828m X 2m)	103.79"
PSV-RL-93696	6' 9" Vertical Diagonals/Bay Brace	21.31 LBS	81"BW X 78.74"HT (2.057m X 2m)	107.98"
PSV-RL-9376	7' Vertical Diagonals/Bay Brace	27.57 LBS	84"BW X 78.74"HT (2.133m X 2m)	110.07"
PSV-RL-9386	8' Vertical Diagonals/Bay Brace	29.41 LBS	96"BW X 78.74"HT (2.438m X 2m)	120.51"
PSV-RL-93866	8' 6" Vertical Diagonals/Bay Brace	23.76 LBS	102"BW X 78.74"HT (2.590m X 2m)	123.32"
PSV-RL-9396	9' Vertical Diagonals/Bay Brace	23.34 LBS	108"BW X 78.74"HT (2.74m X 2m)	128"
PSV-RL-93106	10' Vertical Diagonals/Bay Brace	33.40 LBS	120"BW X 78.74"HT (3.048m X 2m)	137.66"

STVA RING LOCK Swivel Clamp Horizontal Diagonal Brace



STVA Product No.	Product Description	Weight	'A' Dimension
PSV-RL-9446	4' X 6' 6" Bay Swivel Clamp Brace	18.19 LBS	92"
PSV-RL-9456	5' X 6' 6" Bay Swivel Clamp Brace	19.25 LBS	99"
PSV-RL-9466	6' X 6' 6" Bay Swivel Clamp Brace	20.33 LBS	106.15"
PSV-RL-9475	7' X 5' Bay Swivel Clamp Brace	19.88 LBS	103-1/4"
PSV-RL-9476	7' X 6' 6" Bay Swivel Clamp Brace	21.67 LBS	115"
PSV-RL-9477	7' X 7' Bay Swivel Clamp Brace	22.26 LBS	108-3/4"
PSV-RL-9478	7' X 8' Bay Swivel Clamp Brace	23.58 LBS	127-1/2"
PSV-RL-9486	8' X 6' 6" Bay Swivel Clamp Brace	22.99 LBS	123.69"
PSV-RL-94866	8' 6" X 6' 6" Bay Swivel Clamp Brace	23.65 LBS	128"
PSV-RL-9488	8' X 8' Bay Swivel Clamp Brace	24.82 LBS	140"
PSV-RL-9496	9' X 6' 6" Bay Swivel Clamp Brace	24.44 LBS	133.32"
PSV-RL-94106	10' X 6' 6" Bay Swivel Clamp Brace	25.94 LBS	143.12"

STVA
RING LOCK
Ladder & Brackets



PSV-RL-990717
 Ladder Bracket
 (17" Wide)
 WT. 6.64 LBS



STVA Product No.	Product Description	Weight	Dimension
PSV-RL-960317	3' Ring Lock Galvanized Ladder (Wide)	11.44 LBS	17" C/C OF LEG
PSV-RL-960517	5' Ring Lock Galvanized Ladder (Wide)	18.45 LBS	17" C/C OF LEG
PSV-RL-960617	6' Ring Lock Galvanized Ladder (Wide)	21.95 LBS	17" C/C OF LEG
PSV-RL-961017	10' Ring Lock Galvanized Ladder (Wide)	35.57 LBS	17" C/C OF LEG

STVA
SYSTEM EQUIPMENT
Screw Jacks



Swivel Screw Jack Disclaimer: Swivel Screw Jacks should be anchored to the structure or restrained. Anchors, bolts, or restraints must be able to hold 4 times the shear force that will be applied to the slope. If the angle will exceed 45 degrees, consult a professional engineer before erecting your scaffold structure. STVA recommends that you always consult a professional engineer before designing or erecting any scaffold structure.

STVA Product No.	Product Description	Weight	Dimension
PSV-9903	(15/21) Hollow Screw Jack W/Base Plate	9.3 LBS	15" MAX EXT. / 21" OAL
PSV-9923	(24/30) Hollow Screw Jack W/Base Plate	11.1 LBS	24" MAX EXT. / 30" OAL
PSV-9904	(15/21) Hollow Screw Jack W/Swivel Base Plate	12.1 LBS	15" MAX EXT. / 21" OAL
PSV-9924	(24/30) Hollow Screw Jack W/Swivel Base Plate	14.1 LBS	24" MAX EXT. / 30" OAL

STVA
SYSTEM EQUIPMENT
Starter Collars

- PSV-RL-9901** 9" Starter Collar 3.125 LBS
- PSV-RL-99013** 13" Starter Collar 4.35 LBS
- PSV-RL-9917** 17.5" Starter Collar 5.58 LBS





SYSTEM EQUIPMENT

Accessories



PSV-RL-9800
3' to 5' Expandable Access Gate (Galvanized) 36"-60"
WT. 24.42 LBS



PSV-RL-9100
Rosette (Forged)
WT. 0.99 LBS



PSV-RL-9905N
Spigot For Standard/Verticals
WT. 1.84 LBS



PSV-RL-9908
Rosette Half Clamp
WT. 2.99 LBS



PSV-RL-9950
12" X 3" Locking Caster
WT. 45.1 LBS



PSV-RL-9912
Swivel Adapter Wedge Coupler
WT. 3.52 LBS



PSV-RL-9913
Ridge Adapter Wedge Coupler
WT. 3.12 LBS



PSV-RL-9914
Spigot Adapter Clamp 8.27"
WT. 1.41 LBS



PSV-RL-9916
Clampable Rosette
WT. 2.4 LBS



PSV-RL-9802
30" Swivel Clamp Davit Arm/Tube & Clamp
WT. 26.62 LBS



PSV-RL-9909
12" Ring Lock Caster Adapter
WT. 8.51 LBS



- PSV-TB-6240G** 4' Galvanized Toe Board WT. 5.08 LBS
- PSV-TB-6250G** 5' Galvanized Toe Board WT. 6.09 LBS
- PSV-TB-6270G** 7' Galvanized Toe Board WT. 8.14 LBS
- PSV-TB-6280G** 8' Galvanized Toe Board WT. 9.15 LBS
- PSV-TB-6290G** 9' Galvanized Toe Board WT. 10.1 LBS
- PSV-TB-6200G** 10' Galvanized Toe Board WT. 11.2 LBS

STVA
SYSTEM EQUIPMENT
 Accessories



PSV-RL-9766R 10 Step Right Stair Stringer WT. 41.7 LBS

PSV-RL-9766L 10 Step Left Stair Stringer WT. 41.7 LBS



PSV-RL-9866R 11 Step Right Stair Stringer WT. 44.3 LBS

PSV-RL-9866L 11 Step Left Stair Stringer WT. 44.3 LBS



PSV-RL-9910
 Ring Lock Guard Rail Post
 (Crazy Leg)
 WT. 17.2 LBS

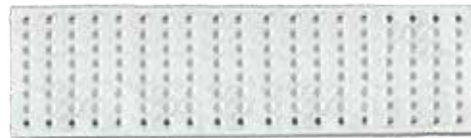

PSV-RL-9730 30" X 9" Stair Tread (Used W/3'6" Ledger) WT. 11.7 LBS

PSV-RL-9736 36" X 9" Stair Tread (Used W/4' Ledger) WT. 13.8 LBS

PSV-RL-9744 44" X 9" Stair Tread (Used W/5' Ledger) WT. 16.6 LBS



PSV-RL-9779
 System Stair Unit
 W/Stair Tread
 WT. 287 LBS



PSV-RL-9919 7' Top Rail For Ring Lock Internal Stair Unit (Hdg) WT. 17.34 LBS



PSV-RL-9911
 23" Safety Vertical For
 Hanging Ring System
 WT. 7.79 LBS

STVA
CUP LOCK
Verticals/Standards

The Cup System can accommodate up to four connections of combined ledgers and braces. Each of these connections can safely carry a load of 5,000 lbs. (11.12kN)

However, the total sum of the ledger loads **MUST NOT** exceed the recommended leg load for given bracing situation.

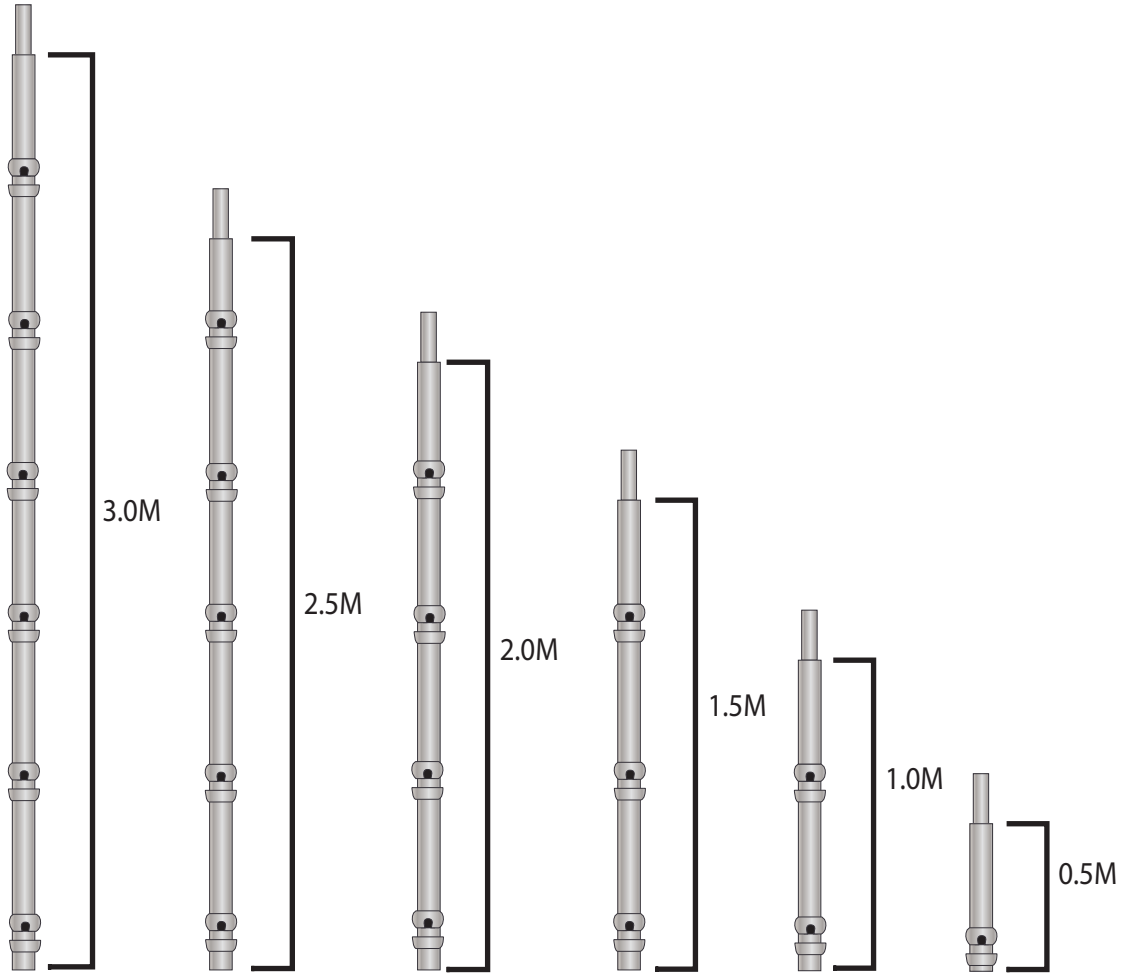

STVA Product No.	Product Description	Weight	Dimension
<i>PSV-CL-8105</i>	Cup 0.5m Vertical W/Spigot 1-Cup	5.61 LBS	1' 7-11/16"
<i>PSV-CL-8110</i>	Cup 1.0m Vertical W/Spigot 2-Cup	11.17 LBS	3' 3-3/8"
<i>PSV-CL-8115</i>	Cup 1.5m Vertical W/Spigot 3-Cup	16.76 LBS	4' 11-1/16"
<i>PSV-CL-8120</i>	Cup 2.0m Vertical W/Spigot 4-Cup	22.33 LBS	6' 6-47/64"
<i>PSV-CL-8125</i>	Cup 2.5m Vertical W/Spigot 5-Cup	27.91 LBS	8' 2-27/64"
<i>PSV-CL-8130</i>	Cup 3.0m Vertical W/Spigot 6-Cup	33.48 LBS	9' 10-7/64"

STVA
CUP LOCK
Horizontal Ledgers

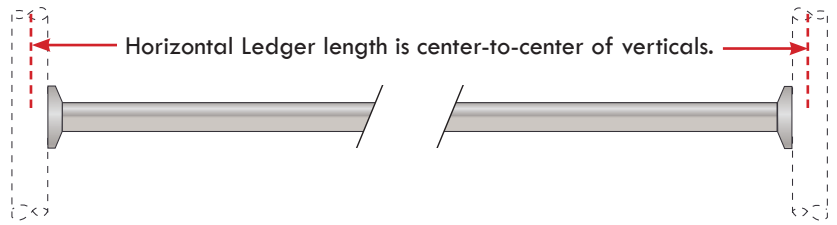

STVA Product No.	Product Description	Weight	Dimension
<i>PSV-CL-82110</i>	Cup 2 Board Bracket Ledger	5.08 LBS	1' 10-1/4"
<i>PSV-CL-8227</i>	Cup 3 Board Bracket Ledger	6.88 LBS	2' 7"
<i>PSV-CL-82060</i>	.60m Cup Ledger (1' 11-5/8")	7.0 LBS	1' 11-5/8"
<i>PSV-CL-82061</i>	2' Cup Ledger	7.2 LBS	2'
<i>PSV-CL-82090</i>	.90m Cup Ledger (2' 11-7/16")	9.0 LBS	2' 11-7/16"
<i>PSV-CL-8230</i>	3' Cup Ledger	7.89 LBS	3'
<i>PSV-CL-8236</i>	3'-6" Cup Ledger	9.10 LBS	3' 6"
<i>PSV-CL-8240</i>	4' Cup Ledger	10.31 LBS	4'
<i>PSV-CL-82125</i>	1.25m Cup Ledger (4' 1-7/32")	11 LBS	4' 1-7/32"
<i>PSV-CL-82150</i>	1.50m Cup Ledger (4' 11-1/16")	14 LBS	4' 11-1/16"
<i>PSV-CL-8250</i>	5' Cup Ledger 1	2.73 LBS	5'
<i>PSV-CL-82180</i>	1.80m Cup Ledger (5' 10-55/64")	16 LBS	5' 10-55/64"
<i>PSV-CL-8260</i>	6' Cup Ledger	15.15 LBS	6'
<i>PSV-CL-8270</i>	7' Cup Ledger	17.57 LBS	7'
<i>PSV-CL-8280</i>	8' Cup Ledger	19.99 LBS	8'
<i>PSV-CL-82250</i>	2.5m Cup Ledger (8' 2-27/64")	22 LBS	8' 2-27/64"
<i>PSV-CL-8290</i>	9' Cup Ledger	22.41 LBS	9'
<i>PSV-CL-82100</i>	10' Cup Ledger	24.83 LBS	10'

STVA
CUP LOCK
Double Ledgers

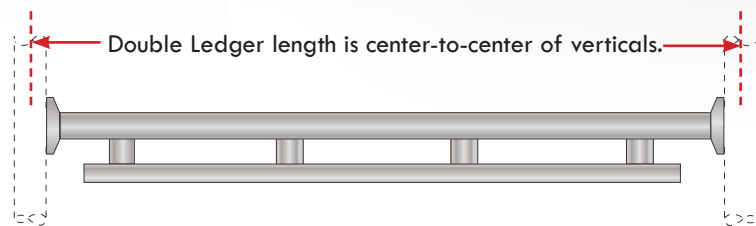

STVA Product No.	Product Description	Weight	Dimension
<i>PSV-CL-8505N</i>	5' Cup Double Ledger	22.0 LBS	5'
<i>PSV-CL-8506N</i>	6' Cup Double Ledger	27.0 LBS	6'
<i>PSV-CL-8507N</i>	7' Cup Double Ledger	31.5 LBS	7'
<i>PSV-CL-8508N</i>	8' Cup Double Ledger	36.0 LBS	8'
<i>PSV-CL-8509N</i>	9' Cup Double Ledger	40.5 LBS	9'
<i>PSV-CL-8510N</i>	10' Cup Double Ledger	45.01 LBS	10'

STVA
CUP LOCK
Trussed Ledger

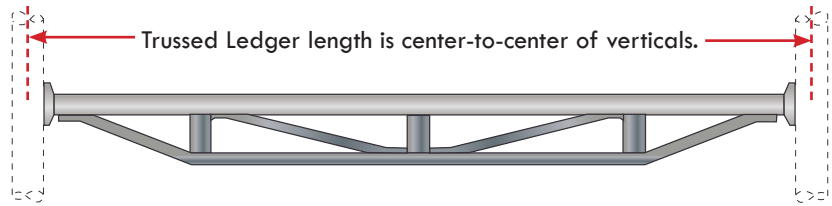

STVA Product No.	Product Description	Weight	Dimension
PSV-CL-8505	5' Cup Truss Ledger	20.48 LBS	5'
PSV-CL-8506	6' Cup Truss Ledger	24.97 LBS	6'
PSV-CL-8507	7' Cup Truss Ledger	29.48 LBS	7'
PSV-CL-8508	8' Cup Truss Ledger	37.5 LBS	8'
PSV-CL-8514	14' Cup Truss Ledger	65.1 LBS	14'
PSV-CL-8516	16' Cup Truss Ledger	90.2 LBS	16'

STVA
CUP LOCK
Bay Brace/Face Brace



STVA Product No.	Product Description	Weight	Dimension
PSV-CL-8346	4' X 6' 6" Cup Bay/Face Brace	16.2 LBS	4' X 6' 6"
PSV-CL-8356	5' X 6' 6" Cup Bay/Face Brace	17.3 LBS	5' X 6' 6"
PSV-CL-8376	7' X 6' 6" Cup Bay/Face Brace	25.71 LBS	7' X 6' 6"
PSV-CL-8386	8' X 6' 6" Cup Bay/Face Brace	25.1 LBS	8' X 6' 6"
PSV-CL-83106	10' X 6' 6" Cup Bay/Face Brace	31.48 LBS	10' X 6' 6"

STVA
CUP LOCK
Board Brackets

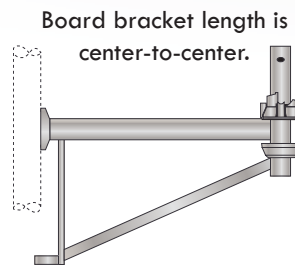

[PSV-CL-8905N](#)
 Cantilever Extension Adapter
 5.0 lbs

STVA Product No.	Product Description	Weight	Dimension
PSV-CL-8601N	1 Board Cup Bracket	3.5 LBS	11.4"
PSV-CL-8602	2 Board Cup Bracket	12.8 LBS	22.2"
PSV-CL-8603	3 Board Cup Bracket	17.3 LBS	31.3"
PSV-CL-82110	Cup 2 Board Bracket Ledger	5.08 LBS	1' 10-1/4"
PSV-CL-8227	Cup 3 Board Bracket Ledger	6.88 LBS	2' 7"

STVA
CUP LOCK
Ladders & Brackets

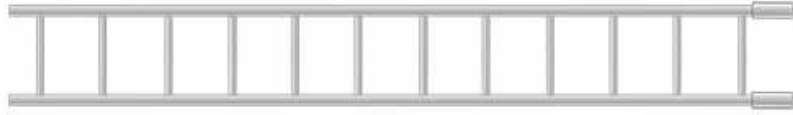

STVA Product No.	Product Description	Weight	Dimension
PSV-CL-8604	3' Cup Lock Galvanized Ladder (Wide)	14.10 LBS	14" C/C OF LEG
PSV-CL-8605	5' Cup Lock Galvanized Ladder (Wide)	22.31 LBS	14" C/C OF LEG
PSV-CL-8610	10' Cup Lock Galvanized Ladder (Wide)	42.24 LBS	14" C/C OF LEG

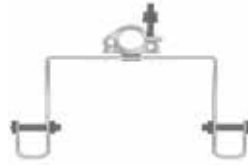

PSV-CL-8907
 Cup Lock Ladder Bracket
 (14" Wide)
 WT. 6.09 LBS

STVA
SHIPPING
Priority



STVA ships a high quantity of containers a year enabling us to have shipping priority with our cargo shipping line provider, Hyundai. Hyundai is widely regarded as one of the top logistical shipping companies in the world. They operate over 165 state of the art vessels in four international headquarters, 28 subsidiaries, 76 branches, six overseas offices, and 10 liaison offices. Their size combined with our shipping output gives us priority of shipping for all of our products. STVA has a written guarantee never to be "bumped" even during peak holiday shipping times. What this means to you as our customer is that you can count on us when we give you an estimated time of arrival for your product.

*Contact us Domestically at (877) 890-8490 or
 Internationally at (0086) 633-8371899
 regarding large quantity purchases.*



Scaffold • Shoring • Tube & Clamp • System

MANUFACTURING & SALES

19902 Hufsmith-Kohrville Rd • Tomball, TX 77375

877-890-8490 | 281-890-6150 (FAX)

www.STVAonline.com | e-mail: order@stvaonline.com

